

G. Hybrid Fixator System and Sheffield Ring Fixator

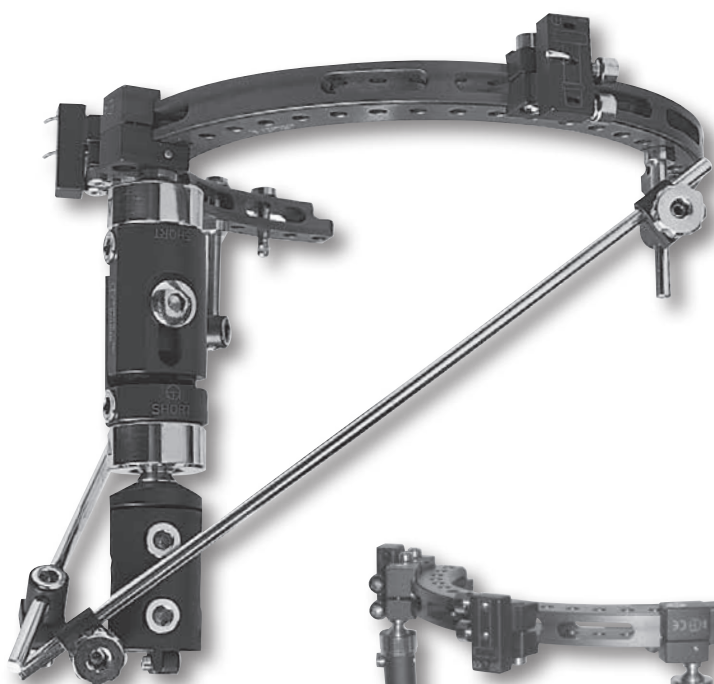

1



2

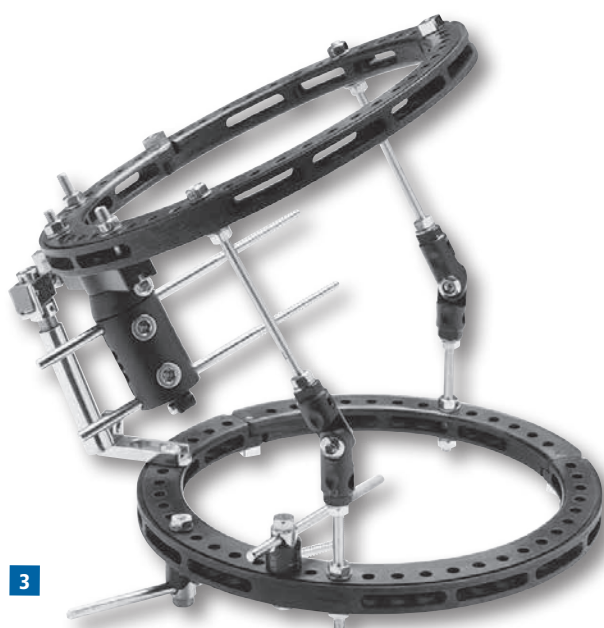

3

1

Hybrid Fixator Assembly

Consisting of: 1 2/3 Ring, 2 Two-Hole X-Wire Securing Pins (80025), 2 Three-Hole Wire Clamp Slider Units (80031), 1 ProCallus Central Body (Short 90029 or Standard 90002), 1 ProCallus Straight Clamp (90006), 1 Hybrid Coupling with Ball-Joint (80050), 2 Posts (80042 or 80044 or 80046), 2 Supplementary Screw Holder Bars (80043 or 10041), 4 Supplementary Screw Holder Clamps (90038).

2

Sheffield Ring Fixator Assembly for Trauma

Consisting of: 2 2/3 Rings, 2 Two-Hole Securing Pins (80025), 2 Three-Hole Wire Clamp Slider Units (80031), 1 Sheffield Clamp (80035), 3 Reduction Units (80047).

3

Sheffield Ring Fixator Assembly for Reconstruction

Consisting of: 2 2/3 Rings, 2 1/3 Rings, 4 Locking Screws (81008), 1 Sheffield Clamp (80035), 2 Hinge Clamps (81015), 4 Threaded Bars and 8 Nuts and Washers, 1 Compression-Distraction Clicker Unit (50008), 2 Extension Plates (81020) and 2 Single Screw Clamps (80074).

See Manual PM 12 "The Ring Fixation System - Part A: The Hybrid Fixator; Part B: The Sheffield Ring Fixator - Standard Trauma Applications; and Part C: The Sheffield Ring Fixator - Limb Reconstruction and Complex Trauma" and Quick Reference Guide PG 120 "The Orthofix Hybrid Fixation System" for application instructions.



1. Components/Replacements

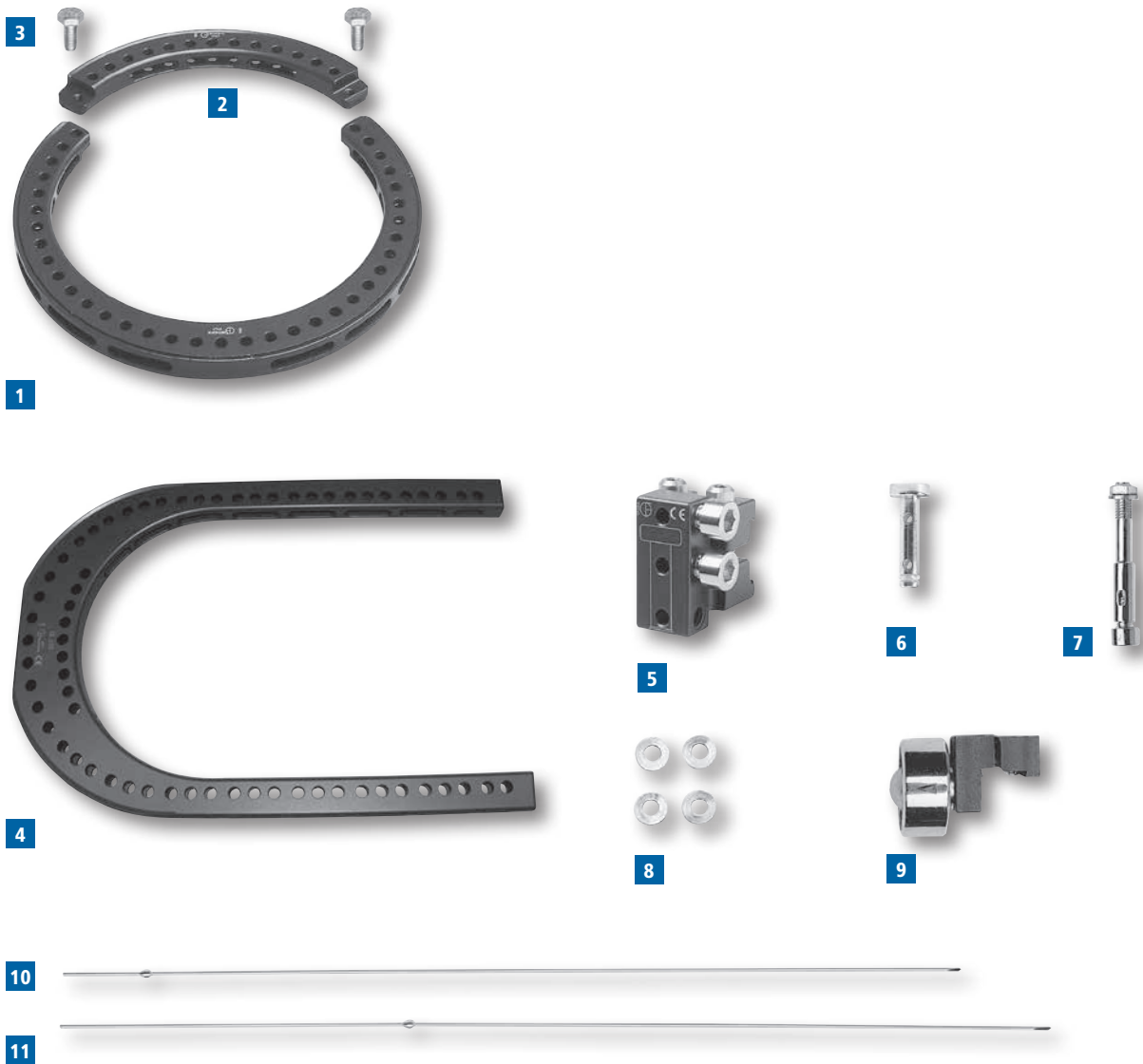

1
2/3 Rings
81050A Inner Ø 125 mm
81000A Inner Ø 150 mm
81002A Inner Ø 175 mm
81004A Inner Ø 190 mm
81006A Inner Ø 220 mm

2
1/3 Rings
81051 Inner Ø 125 mm
81001 Inner Ø 150 mm
81003 Inner Ø 175 mm
81005 Inner Ø 190 mm
81007 Inner Ø 220 mm

3
81008 Ring Locking Screw
 To join 1/3 and 2/3 rings together (two locking screws are necessary).

4
81500 Foot Ring
 Inner Ø 150 mm.
 For wire fixation of the foot.

5
80031 Three-Hole Wire Clamp Slider Unit
 Should be used with 1 or 2 wires only.

6
80025 Two-Hole X-Wire Securing Pin

7
80041 Independent Wire Clamp

8
W2200 F.F.S. Large Washers
 (pack of 4)
 To be used to supplement cortical fixation of wires with a central olive.

9
80050 Hybrid Coupling with Ball-Joint
 For fixator bodies 90000 and 90028.

10
X-Wires with lateral olive Ø 2 mm
80101 Length 310 mm
80111 Length 350 mm
80112 Length 400 mm

11
X-Wires with central olive Ø 2 mm
80121 Length 400 mm
80123 Length 450 mm

12
X-Wires Ø 1.8 mm (not illustrated)
80131 with central olive, length 400 mm
80132 without olive, length 400 mm

13
X-Wire Ø 1.8 mm* (not illustrated)
98-80131 with central olive sterile, length 400 mm
98-80132 without central olive sterile, length 400 mm

**for Japanese markets only*

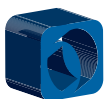

Components/Replacements

16



17



18



21



22



25

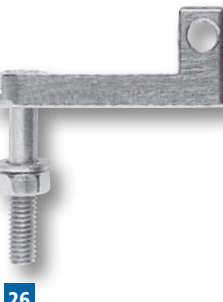

26



27



19



20



23



24

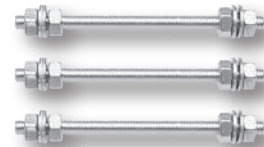

28

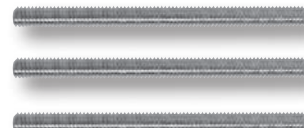

29

16
X-Wires without olive
Ø 2 mm
80122 Length 400 mm
80124 Length 450 mm

17
Supplementary Screw Holder Bars
Ø 6 mm
10039 Length 150 mm
80043 Length 300 mm
10041 Length 400 mm

18
Supplementary Screw Holder Bar
Radiolucent
91039 Length 150 mm
81043 Length 300 mm

19
Posts
80042 Length 50 mm
80044 Length 100 mm
80046 Length 150 mm

20
90038 Supplementary Screw Holder Clamp

21
99-91038 Supplementary Screw
Holder (Bar and Clamps, sterile)

22
Sheffield Clamp
80035 Adult

85035 Paediatric (to be used with
150 mm or smaller diameter rings)

23
80074 Single Screw Clamp

24
80076 Half Pin Fixation Bolt

25
81015 Hinge Clamp
Allows angulation of the frame for
deformity correction. It can also be used as a
clamp to secure a screw or wire.

26
81020 Extension Plate
Allows variable attachment of components
(e.g. hinge clamp, angulated wire) to the ring.

27
81010 Translation Rotation Hinge
Enables translation or rotation between
two rings for the treatment of deformity.
Radiolucent centre allows X-ray targeting
of axis.

28
Threaded Bars with nuts and washers
(set of 3)
80036 Length 80 mm
80037 Length 120 mm
80038 Length 160 mm
80039 Length 200 mm

29
Threaded Bars (set of 3)
81036 Length 80 mm
81037 Length 120 mm
81038 Length 160 mm
81039 Length 200 mm
81048 Length 300 mm
81049 Length 400 mm

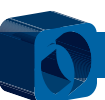

Components/Replacements



30

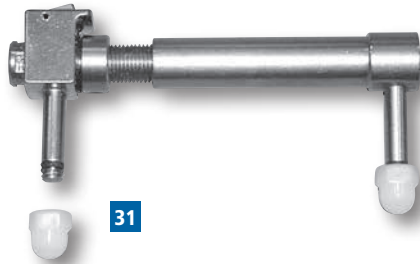

31



32



33



36



34



35

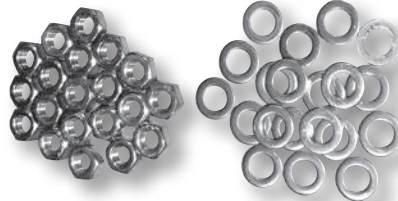

37



38

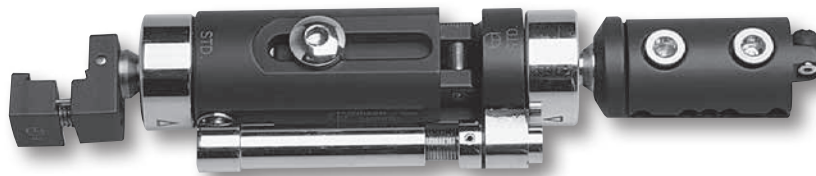

39

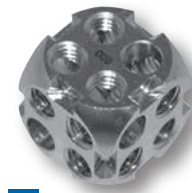

40

30
81025 Counter Nut
 Used for better control of lengthening or as part of a motor for angular deformity correction.

31
Compression-Distraction Clicker Units
50008 Standard
 Extends to 4 cm.
50009 Long
 Extends to 8 cm.

32
80034 Bolts with nuts and washers
 (set of 3)
 Length 60 mm.

33
Bolts (set of 10)
81024 Length 25 mm
81021 Length 35 mm

34
81023 Slotted Washers (pack of 10)
 Provide a single level of wire fixation.

35
74405 Revision Locking Screw Washers
 (pack of 4)
 Used with slotted washers.

36
80047 Reduction Unit
 3 units are required to connect 2 rings.

37
81022 Nuts and Washers
 (pack of 20 of each)

38
80077 Wire Fixation Bolt

39
Hybrid Fixator Assembly Kits
80051 Standard
 Consisting of:
 1x90002 ProCallus Standard Central Body
 1x10008 Compression-Distraction Unit Standard, extends to 4 cm
 1x90006 ProCallus Straight Clamp
 1x80050 Hybrid Coupling with Ball-Joint.

80052 Short
 Consisting of:
 1x90029 ProCallus Short Central Body
 1x10030 Compression-Distraction Unit Short, extends to 2.75 cm
 1x90006 ProCallus Straight Clamp
 1x80050 Hybrid Coupling with Ball-Joint.

40
81018 Magic Cube
 To be used to secure fixation of a bone screw or a wire.

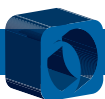

2. Sheffield Ring Fixator Kits

Code Number	Product Name	Quantity
18001	Wire Tensioner	1
18002	Wire Guide	1
10114	Cortical Screw, shaft Ø 6 mm, thread Ø 6-5 mm, 130/40 mm	6
10165	Cortical Screw, shaft Ø 6 mm, thread Ø 6-5 mm, 150/40 mm	6
11002	Drill Bit Kit Ø 4.8 mm, length 240 mm	1
10017	Allen Wrench 6 mm	1
11137	Screw Guide, length 80 mm	3
11103	Screw Guide, length 100 mm	3
11105	Drill Guide Ø 4.8 mm, length 80 mm	1
W1003	Wire Cutter	1
80025	Two-Hole X-Wire Securing Pin	2
80031	Three-Hole Wire Clamp Slider Unit	3
80035	Sheffield Clamp	1
81020	Extension Plate	2
80101	X-Wire with lateral olive, length 310 mm	4
80111	X-Wire with lateral olive, length 350 mm	4
80112	X-Wire with lateral olive, length 400 mm	4
80121	X-Wire with central olive, length 400 mm	4
80123	X-Wire with central olive, length 450 mm	4
80122	X-Wire without olive, length 400 mm	4
80124	X-Wire without olive, length 450 mm	4
81050A	2/3 Ring, Inner Ø 125 mm	2
81000A	2/3 Ring, Inner Ø 150 mm	2
81002A	2/3 Ring, Inner Ø 175 mm	2
81004A	2/3 Ring, Inner Ø 190 mm	2
81006A	2/3 Ring, Inner Ø 220 mm	2
81051	1/3 Ring, Inner Ø 125 mm	2
81001	1/3 Ring, Inner Ø 150 mm	2
81003	1/3 Ring, Inner Ø 175 mm	2
81005	1/3 Ring, Inner Ø 190 mm	2
81007	1/3 Ring, Inner Ø 220 mm	2
81008	Ring Locking Screw	4
81015	Hinge Clamp	2
81030	Speed Wrench	1
81031	Open End Wrench	2
81036	Threaded Bars, length 80 mm (set of 3)	1
81037	Threaded Bars, length 120 mm (set of 3)	1
81038	Threaded Bars, length 160 mm (set of 3)	1
81039	Threaded Bars, length 200 mm (set of 3)	1
81048	Threaded Bars, length 300 mm (set of 3)	1
81049	Threaded Bars, length 400 mm (set of 3)	1
80074	Single Screw Clamp	2
80047	Reduction Unit	3
91017	Universal Allen Wrench	1
81024	Bolts, length 25 mm (pack of 10)	1
81021	Bolts, length 35 mm (pack of 10)	1
81022	Nuts and Washers (pack of 20)	1
81023	Slotted Washers (pack of 10)	1
74405	Revision Locking Screw Washers (pack of 4)	1
W2200	F.F.S. Large Washers (pack of 4)	1

1

81570 Standard Trauma Kit

For all normal trauma indications.



Sheffield Ring Fixator Kits

Code Number	Product Name	Quantity
50008	Standard Compression-Distractor Clicker Unit	3
50009	Long Compression-Distractor Clicker Unit	3
10114	Cortical Screw, shaft Ø 6 mm, thread Ø 6-5 mm, 130/40 mm	3
10165	Cortical Screw, shaft Ø 6 mm, thread Ø 6-5 mm, 150/40 mm	3
80031	Three-Hole Wire Clamp Slider Unit	3
80025	Two-Hole X-Wire Securing Pin	2
80035	Sheffield Clamp	1
81020	Extension Plate	4
81008	Ring Locking Screw	4
81015	Hinge Clamp	4
81025	Counter Nut	3
81010	Translation Rotation Hinge	3
80074	Single Screw Clamp	4
81024	Bolts, length 25 mm (pack of 10)	1
81021	Bolts, length 35 mm (pack of 10)	1
81022	Nuts and Washers (pack of 20)	1

Code Number	Product Name	Quantity
50008	Standard Compression-Distractor Clicker Unit	3
50009	Long Compression-Distractor Clicker Unit	3
10114	Cortical Screw, shaft Ø 6 mm, thread Ø 6-5 mm, 130/40 mm	3
10165	Cortical Screw, shaft Ø 6 mm, thread Ø 6-5 mm, 150/40 mm	3
80025	Two-Hole X-Wire Securing Pin	2
80031	Three-Hole Wire Clamp Slider Unit	2
80035	Sheffield Clamp	1
81020	Extension Plate	2
81008	Ring Locking Screw	2
81015	Hinge Clamp	2
81025	Counter Nut	3
80074	Single Screw Clamp	2
81500	Foot Ring	1
81024	Bolts, length 25 mm (pack of 10)	1
81021	Bolts, length 35 mm (pack of 10)	1
81022	Nuts and Washers (pack of 20)	1

2 81580 Lengthening and Correction of Deformities Kit

Used with the Standard Trauma Kit
for reconstruction indications.

3 81590 Cross Joint and Foot Fixation Kit

Used with the Standard Trauma Kit and
Lengthening and Correction of Deformities Kit
for extended reconstruction indications,
including cross joint and foot fixation.

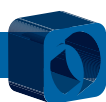

3. Instrumentation

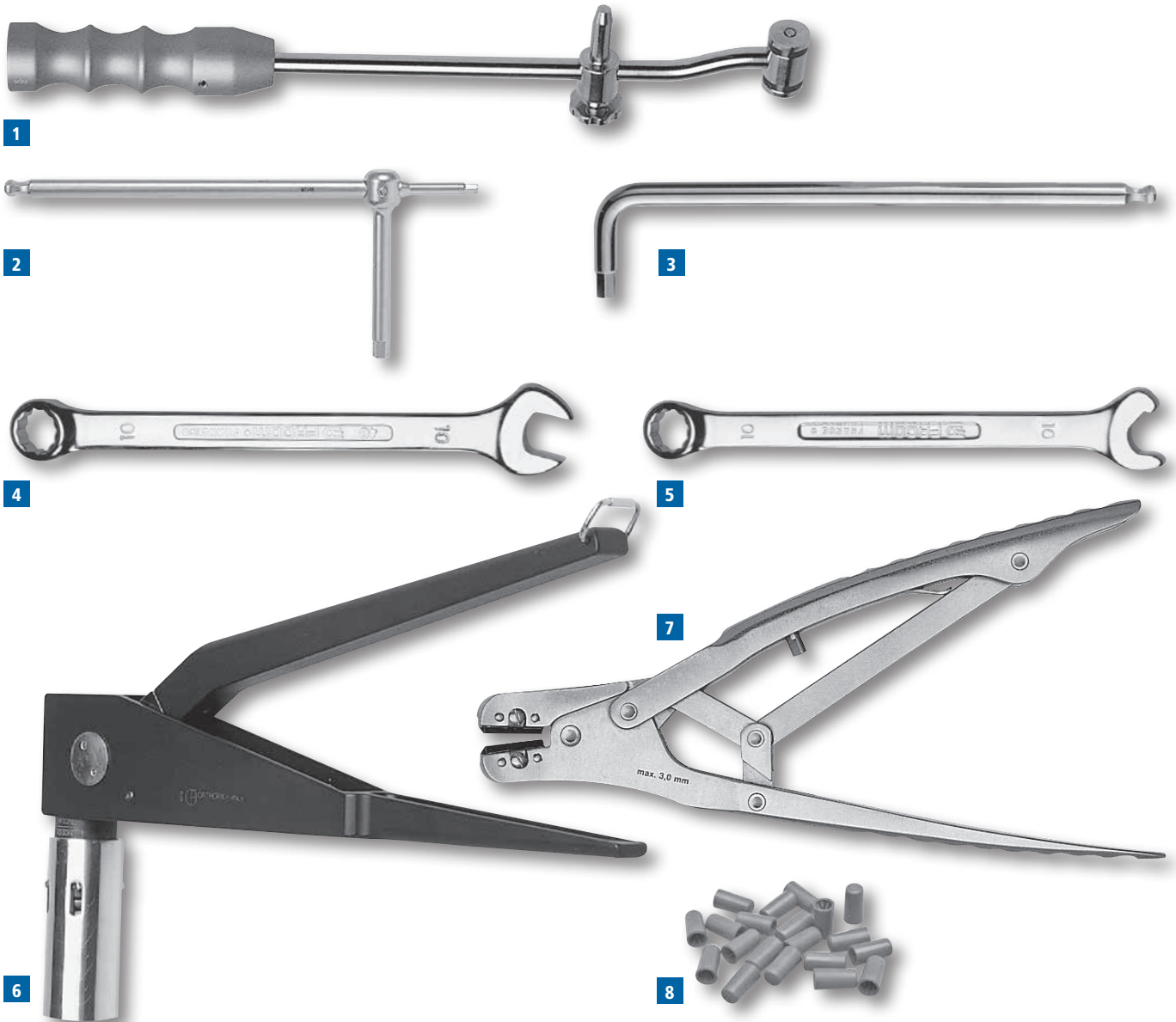

1
18002 Wire Guide

2
91017 Universal Allen Wrench

3
Allen Wrenches
10012 3 mm
30017 5 mm
10017 6 mm

4
81031 Open End Wrench 10 mm
Includes a ring end and an open end
for bolt tightening.

5
81030 Speed Wrench
Includes a ring end and an open end
for fast bolt tightening.

6
18001 Wire Tensioner

7
W1003 Wire Cutter
W1004 Wire Cutter Re-use Kit
Consisting of 2 blades and 2 rubbers.
(Not illustrated)

8
80200 X-Wire Covers
(pack of 20)

Note: See also instrumentation for bone
screw insertion (section "Bone Screws").

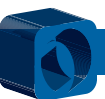

4. Sterilization Boxes

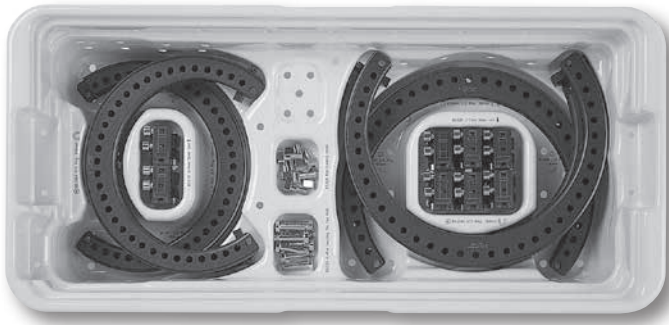

1

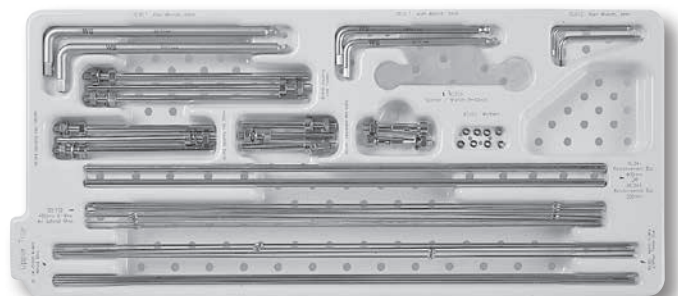
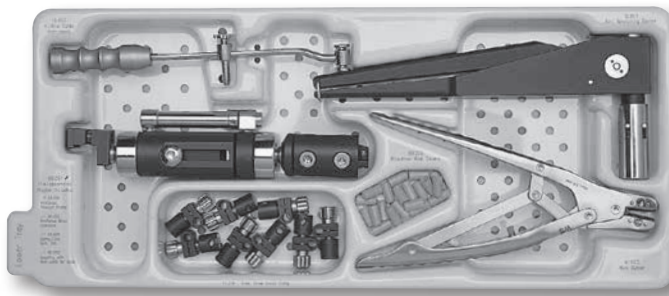

1 81200 Hybrid Fixation System Sterilization Box, empty

Can accommodate:

Base

- 2x81000A 2/3 Ring, inner Ø 150 mm
- 2x81001 1/3 Ring, inner Ø 150 mm
- 2x81004A 2/3 Ring, inner Ø 190 mm
- 2x81005 1/3 Ring, inner Ø 190 mm
- 8x81008 Ring Locking Screw
- 8x80025 Two-Hole X-Wire Securing Pin
- 8x80031 Three-Hole Wire Clamp Slider Unit

Lower Tray

- 1x18002 Wire Guide
- 1x18001 Wire Tensioner
- 1x80051 Hybrid Fixator Standard Assembly Kit

Consisting of: 1 ProCallus Standard Central Body, 1 Compression-Distraction Unit Standard; 1 ProCallus Straight Clamp; 1 Hybrid Coupling with Ball-Joint.

- 1xW1003 Wire Cutter
- 8x90038 Supplementary Screw Holder Clamp
- 1x80200 X-Wire Covers (pack of 20)

Upper Tray

- 2x10017 Allen Wrench 6 mm
- 2x30017 Allen Wrench 5 mm
- 2x10012 Allen Wrench 3 mm
- 2x80041 Independent Wire Clamp
- 3x80042 Post, length 50 mm
- 3x80044 Post, length 100 mm
- 3x80046 Post, length 150 mm
- 2xW2200 F.F.S. Large Washers (pack of 4)
- 2x80043 Supplementary Screw Holder Bar Ø 6 mm, length 300 mm
or
Supplementary Screw Holder Bar Ø 6 mm, length 400 mm
- 2x10041 Supplementary Screw Holder Bar Ø 6 mm, length 400 mm
- 8x80112 X-Wire with lateral olive Ø 2 mm, length 400 mm
- 4x80121 X-Wire with central olive Ø 2 mm, length 400 mm

- 4x80123 X-Wire with central olive Ø 2 mm, length 450 mm
- 4x80122 X-Wire without olive Ø 2 mm, length 400 mm
- 4x80124 X-Wire without olive Ø 2 mm, length 450 mm

Free space is available for other accessories.

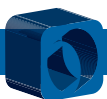

Sterilization Boxes

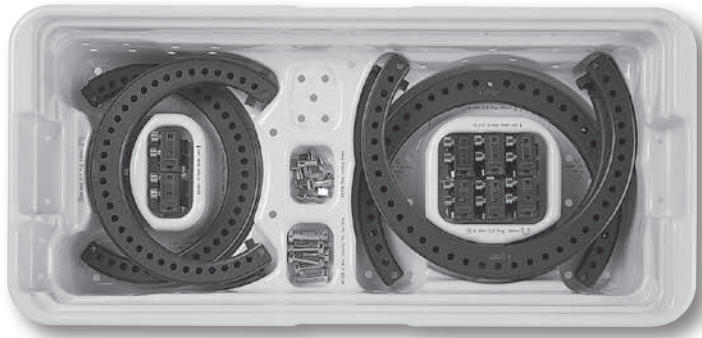

2

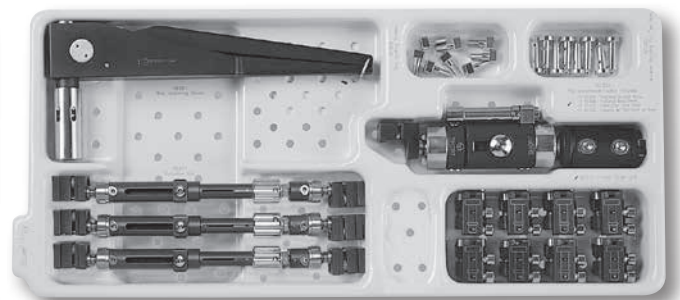
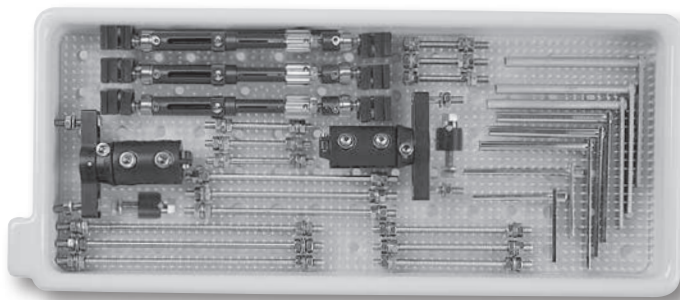

2 81201 Hybrid Fixation System Sterilization Box, empty

Can accommodate:

Base

- 2x81006A 2/3 Ring, inner Ø 220 mm
- 2x81007 1/3 Ring, inner Ø 220 mm
- 2x81002A 2/3 Ring, inner Ø 175 mm
- 2x81003 1/3 Ring, inner Ø 175 mm

Lower Tray (Generic)

- 2x80035 Sheffield Clamp
- 2x80074 Single Screw Clamp
- 3x80047 Reduction Unit
- 3x11137 Screw Guide, length 80 mm
- 3x11103 Screw Guide, length 100 mm
- 1x11105 Drill Guide Ø 4.8 mm, length 80 mm
- 1x11138 Drill Guide Ø 4.8 mm, length 60 mm
- 1x80034 Bolts 60 mm (set of 3)
- 1x80036 Threaded Bars, length 80 mm (set of 3)
- 1x80037 Threaded Bars, length 120 mm (set of 3)

- 1x80038 Threaded Bars, length 160 mm (set of 3)
- 1x80039 Threaded Bars, length 200 mm (set of 3)

Upper Tray

- 1x18001 Wire Tensioner
- 8x81008 Ring Locking Screw
- 8x80025 Two-Hole X-Wire Securing Pin
- 1x80052 Hybrid Fixator Short Assembly Kit
Consisting of: 1 ProCallus Straight Clamp, 1 ProCallus Short Central Body, 1 Compression-Distraction Unit Short, 1 Hybrid Coupling with Ball-Joint.
- 3x80047 Reduction Unit
- 8x80031 Three-Hole Wire Clamp Slider Unit

Free space is available for other accessories.

