

L. Galaxy Fixation™ System (93000 Series)

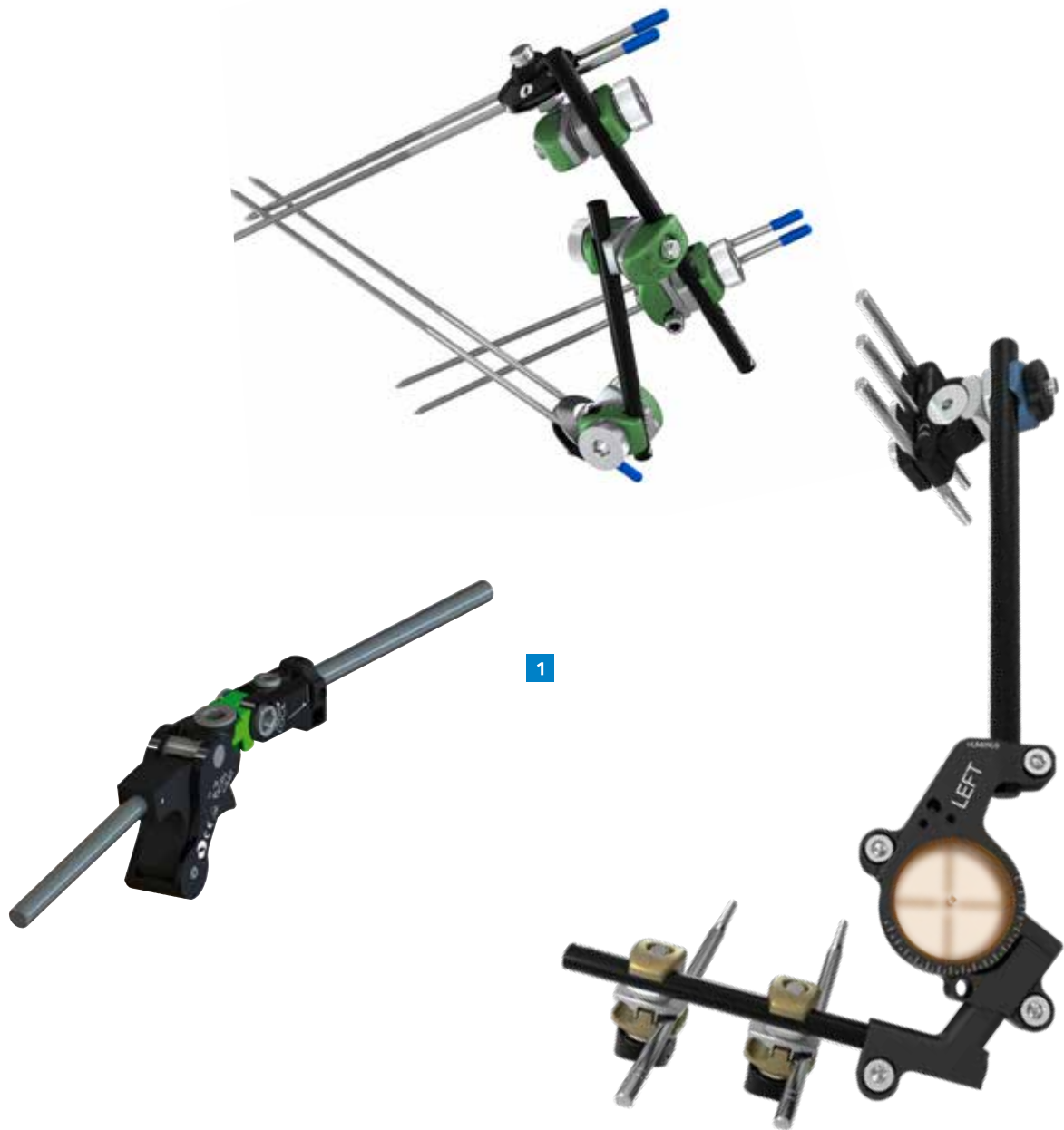

1

1
Galaxy Fixation System (93000 series)

See Operative Technique GF-1101-OPT and GF-1102-OPT Galaxy for application instructions



Manufactured by:
ORTHOFIX Srl
Via Delle Nazioni 9, 37012 Bussolengo (Verona), Italy
Telephone +39 045 6719000, Fax +39 045 6719380



1. Components/Replacements



1



2



3



6

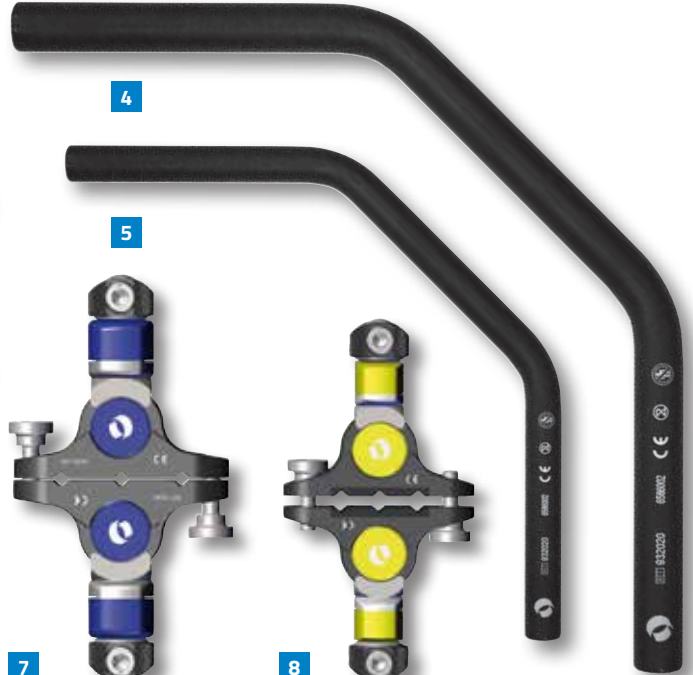

4



7



8



9



10



11



12



13



14

- 1**
Rods \varnothing 12mm 
932100 Length 100mm
932150 Length 150mm
932200 Length 200mm
932250 Length 250mm
932300 Length 300mm
932350 Length 350mm
932400 Length 400mm
99-932450 Length 450mm, sterile*
99-932500 Length 500mm, sterile*
99-932550 Length 550mm, sterile*
99-932600 Length 600mm, sterile*
99-932650 Length 650mm, sterile*

* Special order only

- 2**
Rods \varnothing 9mm 
939100 Length 100mm
939150 Length 150mm
939200 Length 200mm
939250 Length 250mm
939300 Length 300mm

- 3**
Rods \varnothing 6mm 
936060 Length 60mm
936080 Length 80mm
936100 Length 100mm
936120 Length 120mm
936140 Length 140mm
936160 Length 160mm
936180 Length 180mm
936200 Length 200mm

- 4**
Semi-Circular Rods \varnothing 12mm
932010 Length 180mm
932020 Length 215mm
932030 Length 250mm

- 5**
Semi-Circular Rods \varnothing 9mm
939010 Small 115mm long
939020 Medium 140mm long
939030 Large 165mm long

- 6**
L Rod \varnothing 6mm
936010 6mm L Rod

- 7**
93040
Large Double Multiscrew Clamp 

- 8**
93140
Medium Double Multiscrew Clamp 

- 9**
93020 Multi Screw Clamp 

- 10**
93120 Medium Multiscrew Clamp 

- 11**
93030 Large-Medium Transition Clamp 

- 12**
93010 Large Clamp 

- 13**
93110 Medium Clamp 

- 14**
93310 Small Clamp 

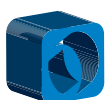

GALAXY FIXATION SYSTEM

All rods and clamps are also available single-packed and sterile.
 They can be ordered using the above code numbers preceded by 99- (e.g. 99-932100)

Components/Replacements



15



16



17



18

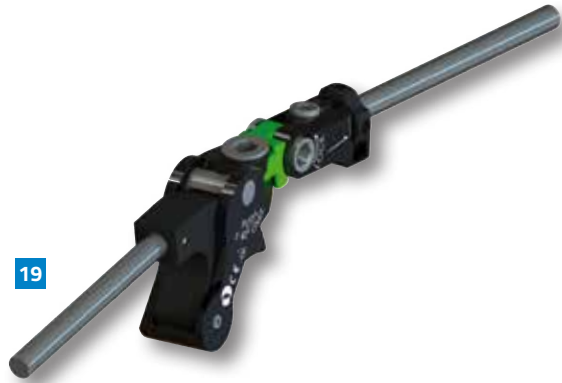

19



20

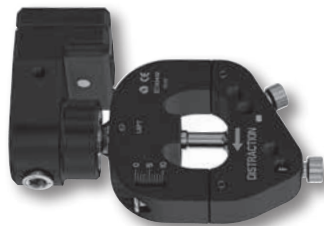

21



22



23

15
93410 Elbow Hinge 

93415 Elbow Hinge Screw Kit

16
93420 Elbow Motion Unit
93421 Screws for Elbow Motion Unit
(Pack of 2stoppers - not illustrated)

17
93620 Wire Locking Clamp

18
93100 Threaded Wires
99-93100 Threaded Wires Sterile
(not illustrated)

19
93350 Wrist Module 

20
93431 Humeral Distractor Clamp

21
93432 Ulnar Distractor Clamp
93434 Distractor Cam (not illustrated)

22
93320 Small Multiscrew Clamp-Long 

23
93330 Small Multiscrew Clamp-Short 

Note: please see also the section "Bone Screws" for all the Bicortical Bone Screws and Transfix Pins available.

Note: all the Galaxy Fixation components marked with "" are MR conditional. All components of Galaxy Fixation System frames must be identified as MR Conditional prior to being placed in or near an MR Environment. Full MRI safety information is available in the MRI safety Information section of the PQGAL.

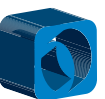

2. Template and Instrumentation

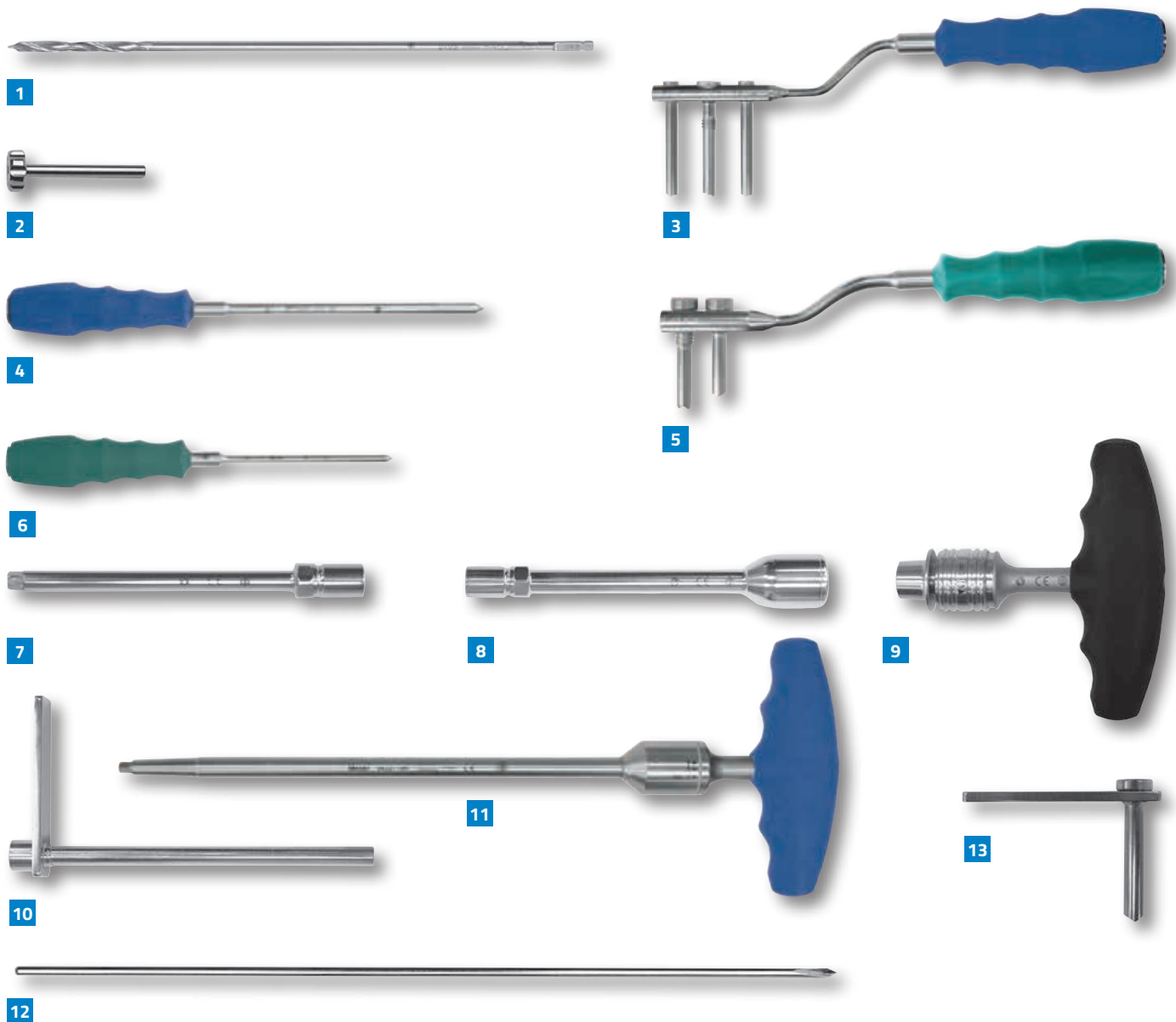

1
Drill Bit Coated - Quick Connect
1-1355001 Ø 2.7 x 127mm
1-1300301 Ø 3.2 x 140mm
1-1100301 Ø 3.2 x 200mm
1-1100101 Ø 4.8 x 180mm
1-1100201 Ø 4.8 x 240mm

2
13530 Drill Guide Ø 2.7mm

3
19940 Multi Screw Clamp Guide

4
19955 Trocar

5
19960 Wrist Guide Template with Handle

6
19965 Tapered Trocar

7
93017 Wrench 5mm Shaft Connection

8
93155 Screw Shaft Connection

9
93150 Ratcheting T Handle

10
19950 Drill Guide Ø 3.2mm L 100mm

11
93440 Wrench 5mm

12
13715 Kirschner Wire (Pack of 2)
L 150mm Ø 1.5mm

13
19995 Screw Guide

Note: See also instrumentation for bone screw insertion (section "Bone Screws")

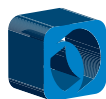

Template and Instrumentation

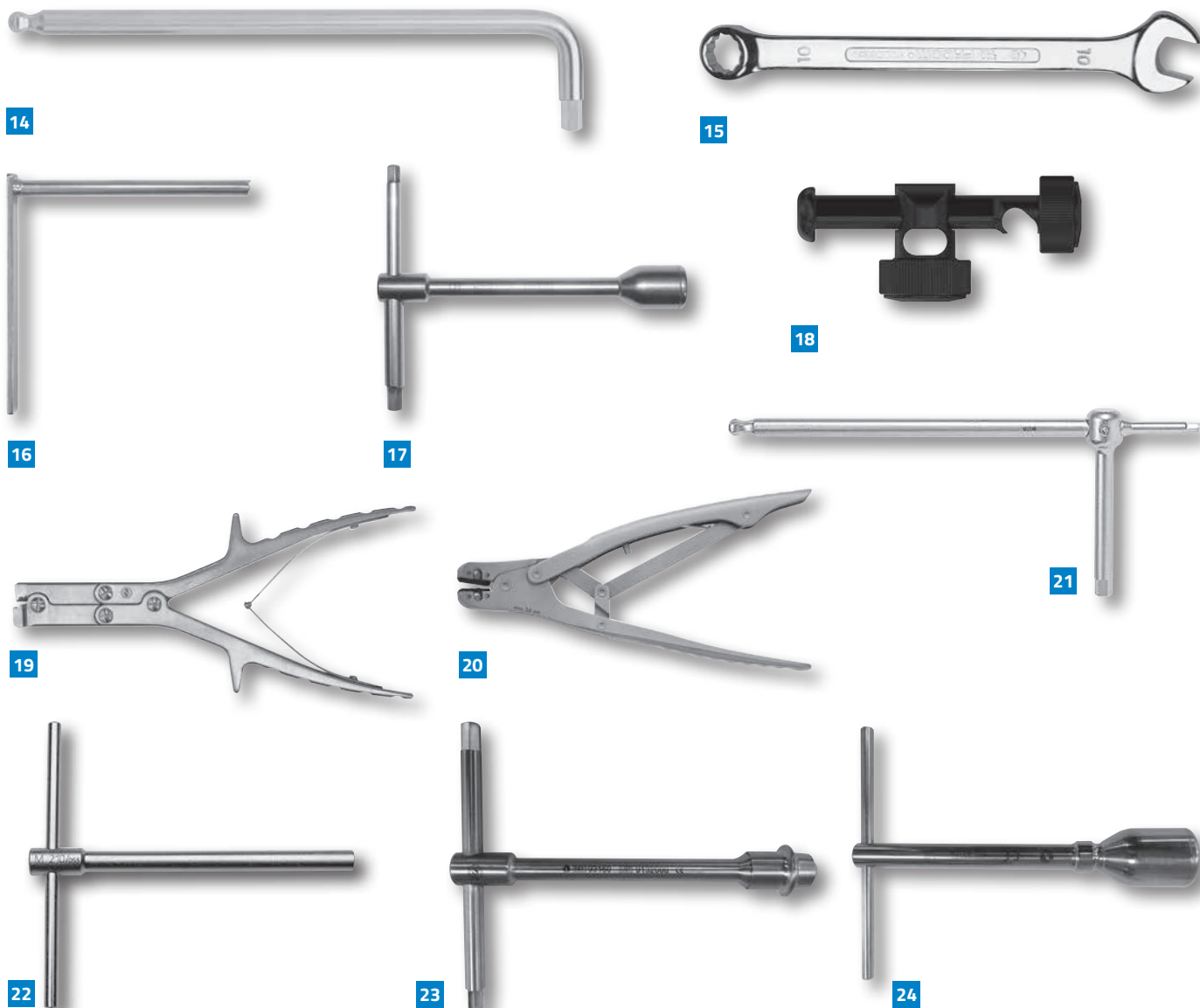

14
30017 Allen Wrench 5mm

15
81031 Open End Wrench

16
19970 Wire Guide

17
91150 Universal "T" Wrench

18
19975 Wire Targeting Device

19
19980 Wire Bender

20
W1003 Wire Cutter

Note: this component is not included within the Steribox

21
91017 Universal Allen Wrench

22
M210 T Wrench

23
93160 Screw T Wrench QC

24
93175 T Wrench 4mm Shaft

Note: See also instrumentation for bone screw insertion (section "Bone Screws")

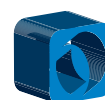

3. Sterile Kits

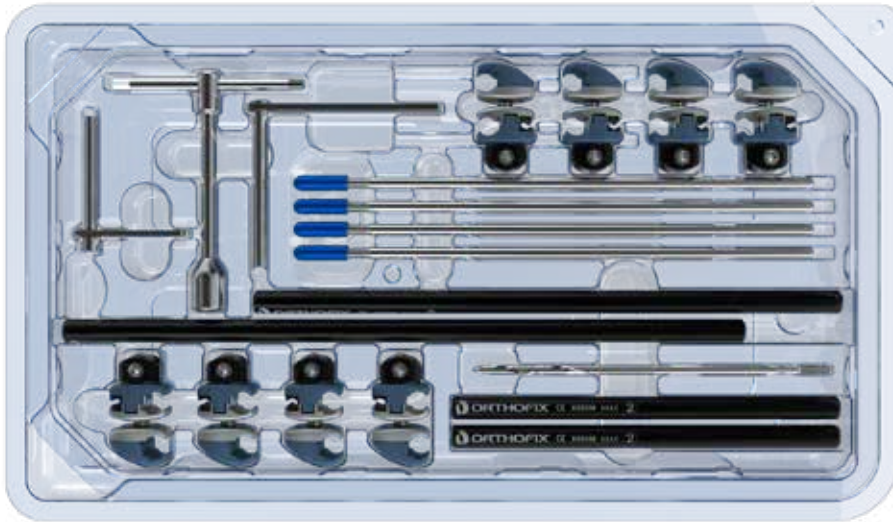

1

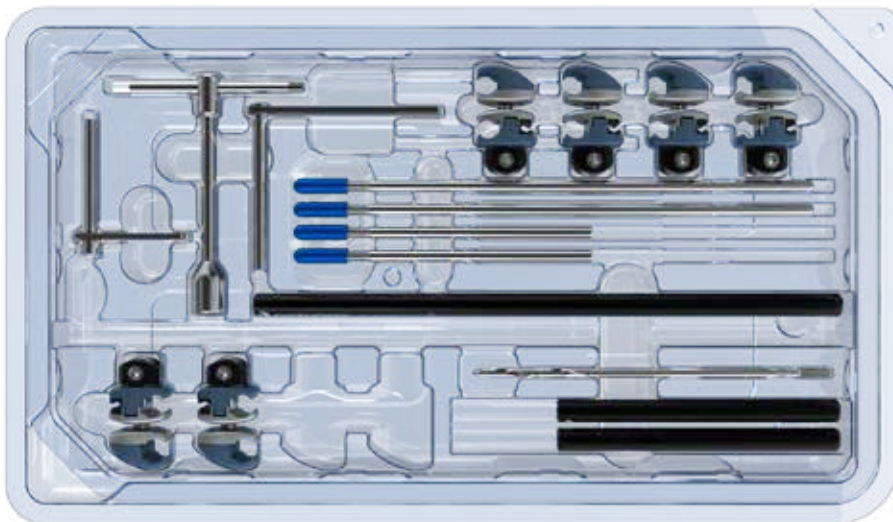

2

1
99-93501 Pelvis Sterile Kit

Consisting of:

- 8x93010 Large Clamp
- 1x932350 Rod Ø 12mm L 350mm
- 1x932300 Rod Ø 12mm L 300mm
- 2x932200 Rod Ø 12mm L 200mm
- 4x912640 Self-drilling XCaliber Screws, L 260mm, thread length 40mm
- 1x11138 Drill Guide Ø 4.8mm
- 1x11137 Screw Guide 80mm
- 1x1-1100101 Drill Bit Ø 4.8x180mm Coated - Quick Connect
- 1x91150 Universal "T" Wrench

2
99-93502 Lower Limb Diaphyseal Sterile Kit

Consisting of:

- 6x93010 Large Clamp
- 1x932300 Rod Ø 12mm L 300mm
- 2x932150 Rod Ø 12mm L 150mm
- 2x912650 Self-drilling XCaliber Screws, L 260mm, thread length 50mm
- 2x911550 Self-drilling XCaliber Screws, L 150mm, thread length 50mm
- 1x11138 Drill Guide Ø 4.8mm
- 1x11137 Screw Guide 80mm
- 1x1-1100101 Drill Bit Ø 4.8x180mm Coated - Quick Connect
- 1x91150 Universal "T" Wrench



Sterile Kits

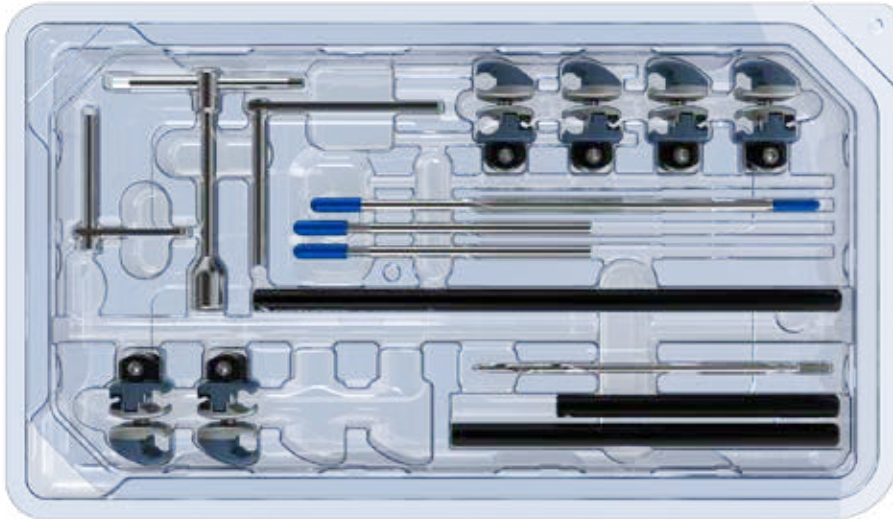

3

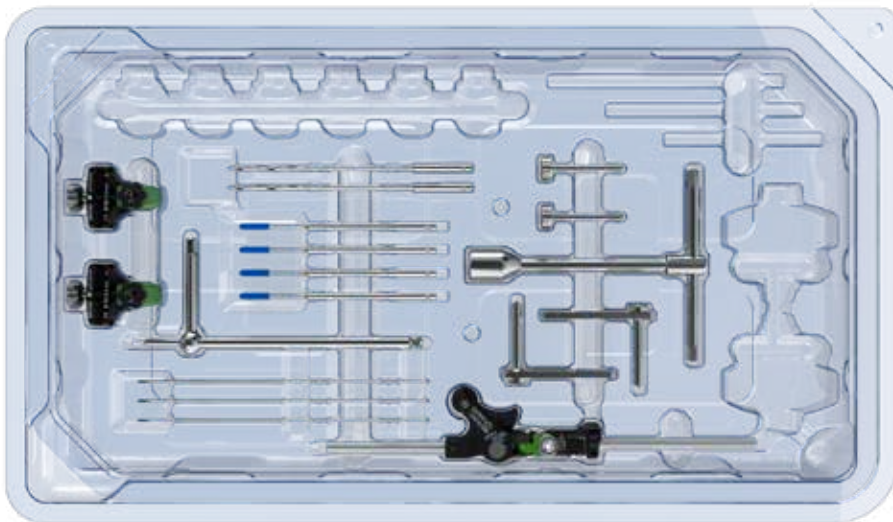

4

3 99-93503 Ankle Sterile Kit

Consisting of:

6x93010	Large Clamp
1x932300	Rod Ø 12mm L 300mm
1x932200	Rod Ø 12mm L 200mm
1x932150	Rod Ø 12mm L 150mm
2x911540	Self-drilling XCaliber Screws, L 150mm, thread length 40mm
1x11138	Drill Guide Ø 4.8mm
1x11137	Screw Guide 80mm
1x1-1100101	Drill Bit Ø 4.8x180mm Coated - Quick Connect
1x91150	Universal "T" Wrench
1x93080	Transfix Pin 80mm

4 99-93601 Galaxy Wrist Sterile Kit

Consisting of:

2x93330	Small multiscrew clamp-SHORT
1x93350	Wrist Module
2x19995	Screw Guide
2x13530	Drill guide Ø 2.7mm
1x91017	Allen Wrench
4x947320	Self Drilling XCaliber Cylindrical Screw Shaft Ø 4mm Thread 3mm L 100/20 QC
2x1-1355001	Drill Bit Ø 2,7mm
1x93160	Screw T Wrench QC
3x13715	Kwire Ø 1,5x150mm



Sterile Kits

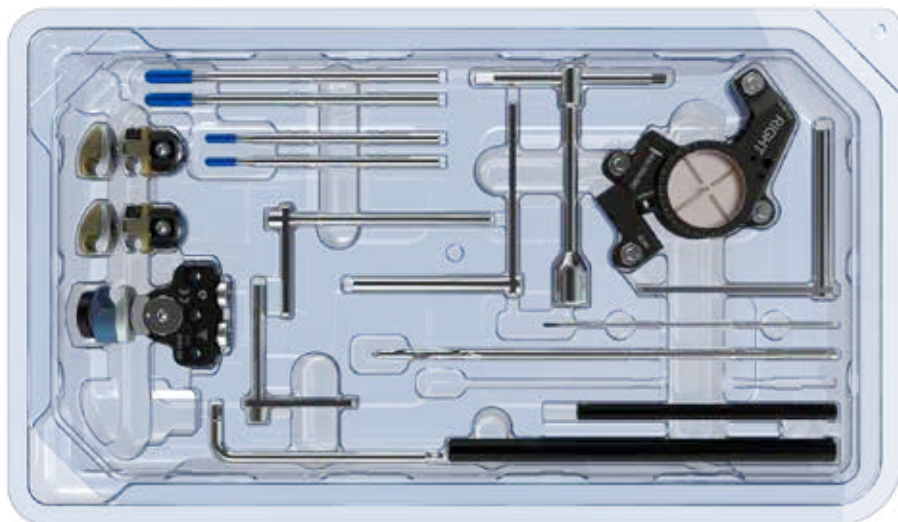

5

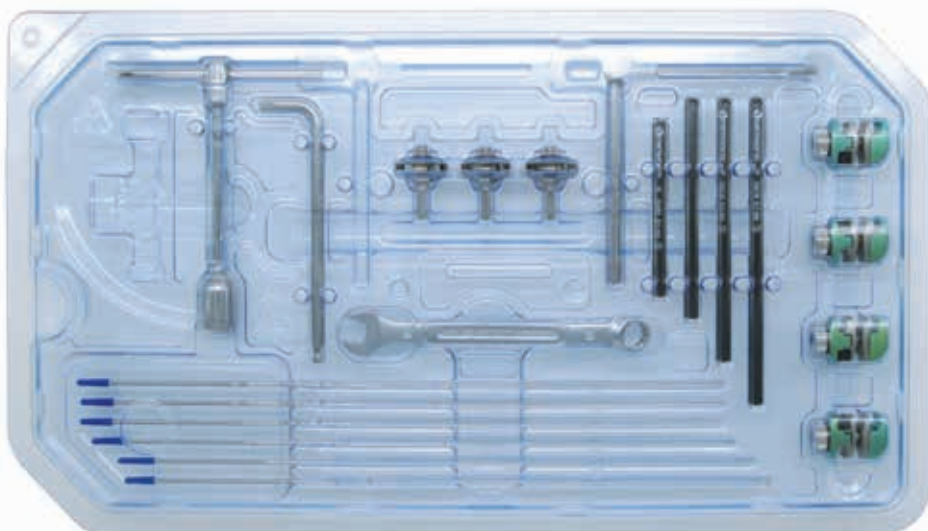

6

5 99-93504 Galaxy Elbow Kit

Consisting of:

1x93020	Multiscrew Clamp
2x93110	Medium Clamp
1x93410	Elbow Hinge
1x932200	Rod Ø 12mm L 200mm
1x939150	Rod Ø 9mm L 150mm
1x30017	Allen Wrench 5mm
1x91150	Universal "T" Wrench
1x1-1100201	Drill Bit Ø 4.8x240mm
1x11138	Drill guide d 4.8mm
2x11137	Screw Guide 80mm
1x19950	Drill Guide d 3.2mm L 100mm
1x1-1100301	Drill Bit Ø 3,2x200mm QC
2x911530	Xcaliber Screws 150/30
2x10137	Cortical Screws 120/20 D 4,5/3,5 Shaft 6mm
1x11146	X-Wire without olive Ø 2mm Length 150mm

6 99-93505 Galaxy Shoulder Sterile Kit

Consisting of:

4x93310	Small Clamp
3x93620	Wire Locking Clamp
1 x936080	Rod Ø 6mm L 80mm
1 x936100	Rod Ø 6mm L 100mm
1x936120	Rod d 6mm L 120mm
1x936140	Rod d 6mm L 140mm
1x30017	Allen Wrench 5mm
1 x19970	Wire Guide
1x91150	Universal "T" Wrench
1x81031	Open end wrench
6 x93100	300mm Threaded wire

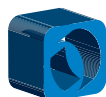

Sterile Kits

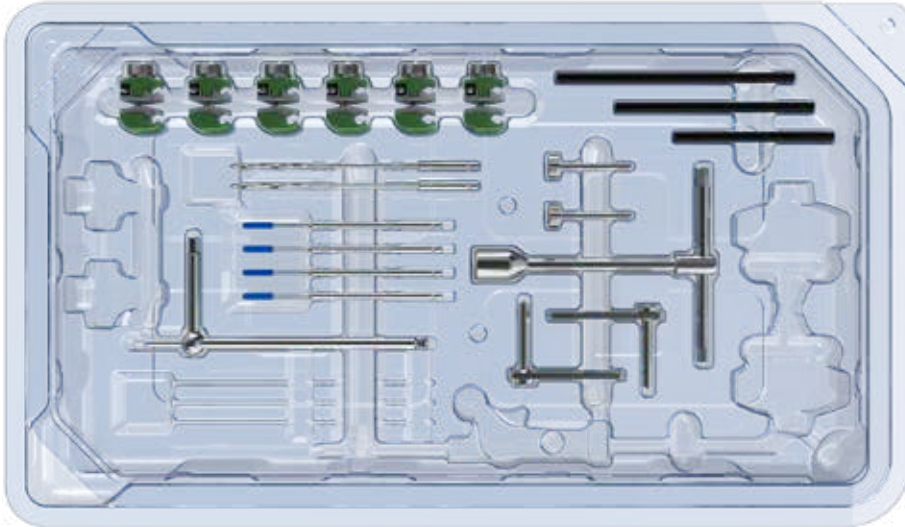

7

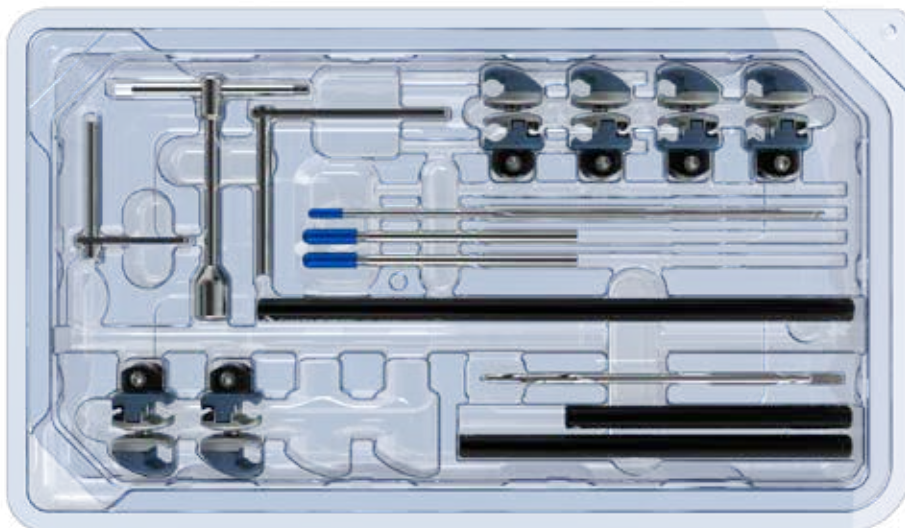

8

7 99-93498 Galaxy Small Z-Configuration Sterile Kit

Can accommodate:

6x93310	Small clamp
1x936120	Rod Ø 6mm L 120mm
1x936100	Rod Ø 6mm L 100mm
1x936080	Rod Ø 6mm L 80mm
2x19995	Sleeve 4,5mm
2x13530	Drill guide d 2.7mm
1x91017	Allen Wrench
4x947320	Self Drilling XCaliber Cylindrical Screw Shaft Ø 4mm Thread 3mm L 100/20 QC
2x1-1355001	Drill Bit Ø 2,7mm
1x93160	"T" Wrench AO QC

8 99-93499 Ankle Sterile Kit - Transfix Pin Ø4mm

Can accommodate:

4x93010	Large Clamp
2x93030	Transitional Clamp
1x932300	Rod Ø 12mm L 300mm
1x932200	Rod Ø 12mm L 200mm
1x932150	Rod Ø 12mm L 150mm
2x911540	XCaliber Screws
1x11138	Drill guide Ø 4.8mm
1x11137	Screw Guide 80mm
1x1-1100101	Drill Bit Ø 4.8x180mm
1x91150	Universal "T" Wrench
1x92080	Transfix Pin thread length 80mm, thread Ø 5mm, shaft 4mm

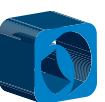

4. PAEDIATRIC Sterile Kits

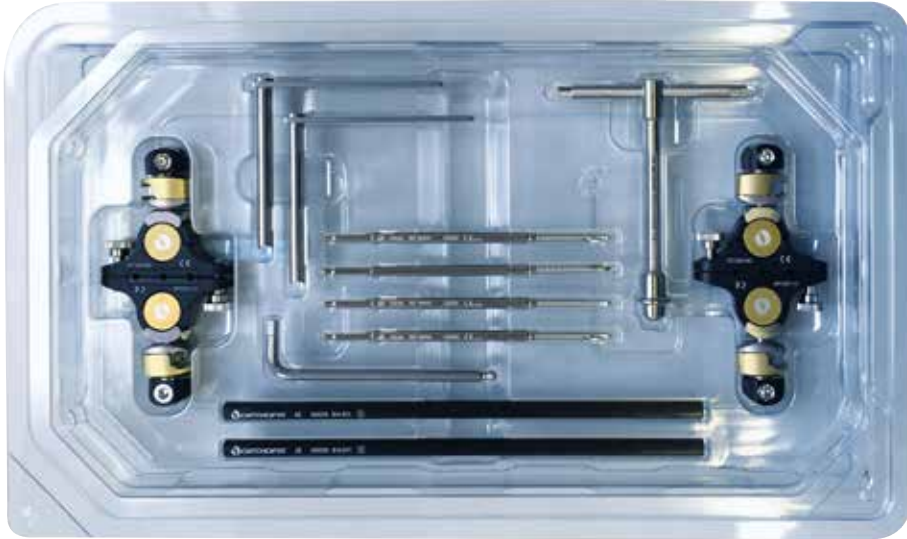

1

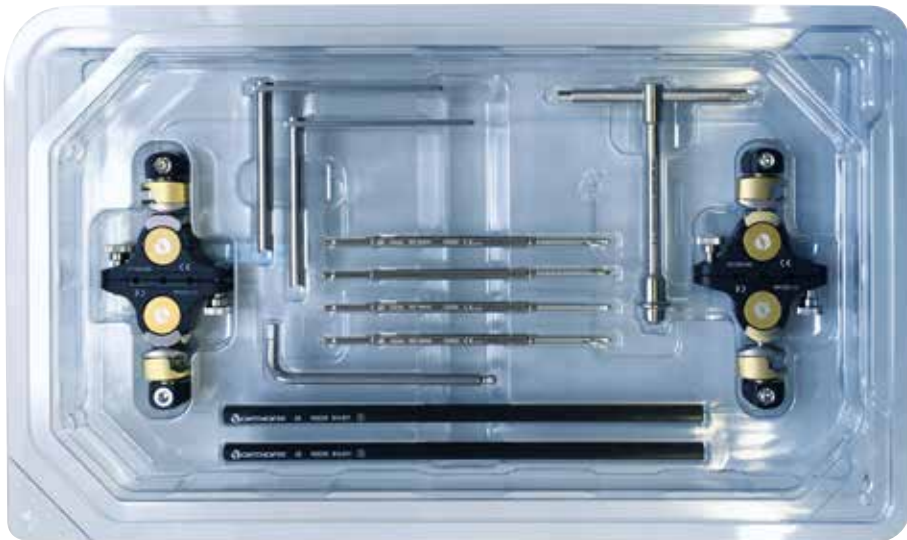

2

1 99-93520 Galaxy Medium - Paediatric Sterile Kit - Ø5mm Screw Thread

Consisting of:

2x93140	Medium Double Multiscrew Clamp
2x939250	Rod Ø 9mm L250mm
4x944540	Selfdrilling XCaliber Cylindrical Screw shaft Ø 6mm thread 5mm L150/40QC
2x11137	Screw guide 80mm
1x30017	Allen Wrench 5mm
1x93160	QC Wrench

2 99-93521 Galaxy Medium - Paediatric Sterile Kit - Ø4mm Screw Thread

Consisting of:

2x93140	Medium Double Multiscrew Clamp
2x939250	Rod Ø 9mm L250mm
4x945430	Selfdrilling XCaliber Cylindrical Screw shaft Ø 6mm thread 4mm L150/30QC
2x11137	Screw guide 80mm
1x30017	Allen Wrench 5mm
1x93160	QC Wrench

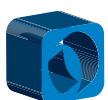

5. Sterilization Boxes



1

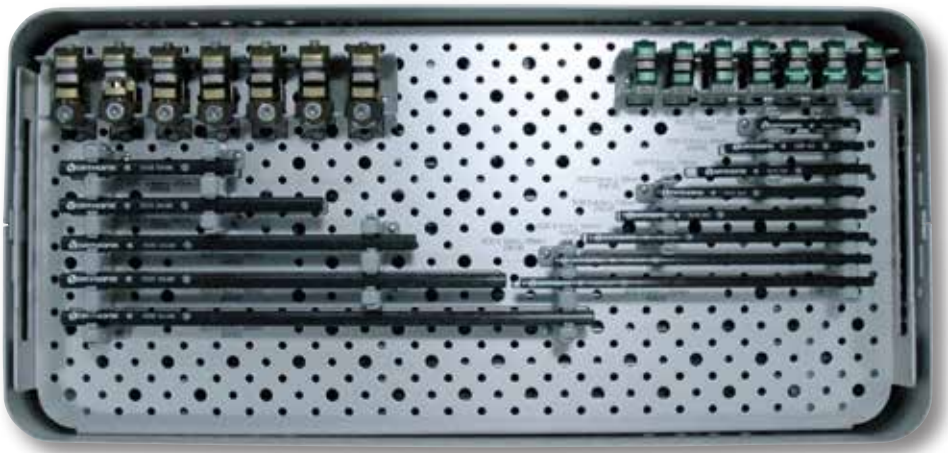

1 93991 Galaxy Upper + Lower Sterilization Box, empty

Can accommodate:

Lower Tray

14x93010	Large Clamp
2x93020	Multi Screw Clamp
1x932400	Rod Ø 12mm L 400mm
1x932350	Rod Ø 12mm L 350mm
1x932300	Rod Ø 12mm L 300mm
1x932250	Rod Ø 12mm L 250mm
1x932200	Rod Ø 12mm L 200mm
1x932150	Rod Ø 12mm L 150mm
1x932100	Rod Ø 12mm L 100mm
1x932030	Semi Circular Rod Ø 12mm large
1x932020	Semi Circular Rod Ø 12mm medium
1x932010	Semi Circular Rod Ø 12mm small

Upper Tray

7x93110	Medium Clamp
7x93310	Small Clamp
1x939300	Rod Ø 9mm L 300mm
1x939250	Rod Ø 9mm L 250mm
1x939200	Rod Ø 9mm L 200mm
1x939150	Rod Ø 9mm L 150mm
1x939100	Rod Ø 9mm L 100mm
1x936200	Rod Ø 6mm L 200mm
1x936180	Rod Ø 6mm L 180mm
1x936160	Rod Ø 6mm L 160mm
1x936140	Rod Ø 6mm L 140mm
1x936120	Rod Ø 6mm L 120mm
1x936100	Rod Ø 6mm L 100mm
1x936080	Rod Ø 6mm L 80mm
1x936060	Rod Ø 6mm L 60mm

Other Tray configurations:

93996 Galaxy Lower Sterilization box, empty

93995 Galaxy Upper Sterilization box, empty

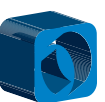

Sterilization Boxes

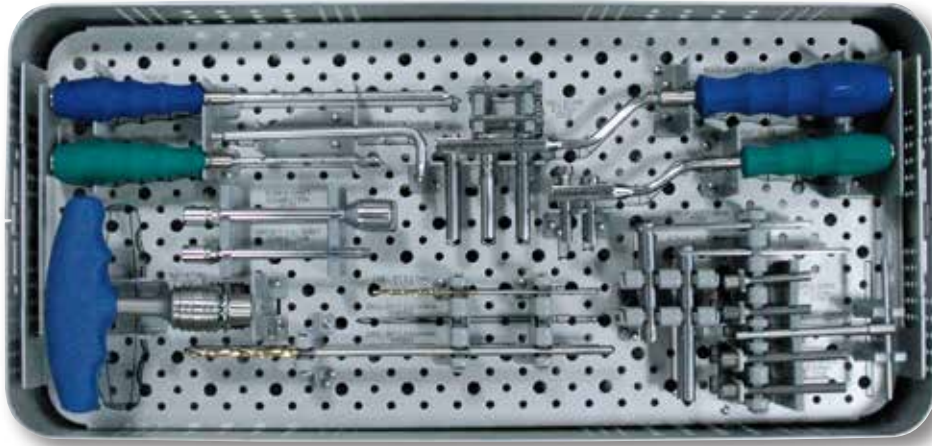

2

2

93992 Galaxy

Instruments Sterilization Box, empty

Can accommodate:

1x19940	Multi Screw Clamp Guide
2x11138	Drill Guide Ø 4.8mm
2x11137	Screw Guide 80mm
2x1-1100201	Drill Bit Ø 4.8x240mm Coated - Quick Connect
2x11106	Drill Guide Ø 3.2mm
2x11102	Screw Guide 60mm
2x1-1300301	Drill Bit Ø 3.2x140mm Coated - Quick Connect
1x19955	Trocar
1x19960	Wrist Guide Template with Handle
2x13530	Drill Guide Ø 2.7mm
2x1-1355001	Drill Bit Ø 2.7x127mm Coated - Quick Connect
1x19965	Tapered Trocar
1xM210	T Wrench
1x93150	Racheting T Handle
1x93155	Screw Shaft Connection

1x30017	Allen Wrench 5mm
1x93017	Wrench 5mm Shaft Connection

Other Tray configurations:

93993 Galaxy Lower + Instruments Sterilization Box, empty

93994 Galaxy Upper + Instruments Sterilization Box, empty

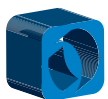

Sterilization Boxes



3



3

93997 Galaxy Elbow

Sterilization Box, empty

Can accommodate:

Base Tray

- 1x93010 Large Clamp
- 1x93020 Multi Screw Clamp
- 2x93110 Medium Clamp
- 1x93410 Elbow Hinge
- 1x932200 Rod \varnothing 12mm L 200mm
- 1x939150 Rod \varnothing 9mm L 150mm
- 1x30017 Allen Wrench 5mm
- 1x19940 Multi Screw Clamp Guide
- 2x1-1100201 Drill Bit \varnothing 4.8x240mm
Coated - Quick Connect
- 2x11138 Drill Guide \varnothing 4.8mm
- 2x11137 Screw Guide 80mm
- 2x11116 Drill Guide \varnothing 3.2mm L 80mm
- 2x19950 Drill Guide \varnothing 3.2mm L 100mm
- 2x11102 Screw Guide 60mm
- 2x1-1300301 Drill Bit \varnothing 3.2x140mm
Coated - Quick Connect

- 2x1-1100301 Drill Bit \varnothing 3.2x200mm
Coated - Quick Connect
- 2x11146 X-Wire without olive \varnothing 2mm
Length 150mm
- 1x19955 Trocar
- Insert Tray
- 2x932200 Rod \varnothing 12mm L 200mm
- 1x93150 Racheting T Handle
- 1x93155 Screw Shaft Connection
- 1x93017 Wrench 5mm Shaft Connection
- 1x10017 Allen Wrench 6mm
- 1x93440 Wrench 5mm
- 1x10025 Torque Wrench 6mm
- 1x93431 Humeral Distractor Clamp
- 1x93432 Ulnar Distractor Clamp
- 1x93420 Elbow Motion Unit

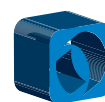

Sterilization Boxes



4



5

4 93998 Galaxy Shoulder Sterilization Box, empty

Can accommodate:

4x93310	Small Clamp
3x93620	Wire Locking Clamp
1x936080	Rod Ø 6mm L 80mm
1x936100	Rod Ø 6mm L 100mm
1x936120	Rod Ø 6mm L 120mm
1x936140	Rod Ø 6mm L 140mm
1x30017	Allen Wrench 5mm
1x19975	Wire Targeting Device
2x19970	Wire Guide
1x19980	Wire Bender
1x91150	Universal "T" Wrench
1x81031	Open End Wrench

5 93999 Galaxy Wrist Tray, empty

Can accommodate:

2x93320	Small Multiscrew Clamp-Long
2x93330	Small Multiscrew Clamp-Short
6x93310	Small Clamp
1x93350	Wrist Module
1x936200	Rod d 6mm L 200mm
2x936100	Rod d 6mm L 100mm
1x936080	Rod d 6mm L 80mm
1x936120	Rod d 6mm L 120mm
3x13715	Xwire d1,5x150mm
1x936010	6mm L Rod
2x19995	Screw Guide
2x13530	Drill Guide Ø 2.7mm
1x91017	Allen Wrench
2x1-1355001	Drill Bit Ø 2.7mm
1x19965	Tapered Trocar
1xM210	T Wrench
1x93160	Screw T Wrench QC
1x93175	T Wrench 4mm Shaft

