

N. Fitbone™ Intramedullary Lengthening System



See Operative Technique FB-2020-OPT
"Fitbone TAA Retrograde Femur Application".



Manufactured by:
ORTHOFIX Srl
Via Delle Nazioni 9, 37012 Bussolengo (Verona), Italy
Telephone +39 045 6719000, Fax +39 045 6719380



1. Fitbone TAA Intramedullary Nail Types

The following variants of the implantable FITBONE system components are CE marked.

Part #	FITBONE TAA variants	Initial total length (mm)	Diameter (mm)	Stroke (mm)	Max Total length after distraction (mm)
Femur Variants					
60001921	TAA0940-F-200	200	9	40	240
60001764	TAA0960-F-220	220	9	60	280
60001383	TAA1140-F-205	205	11	40	245
60001468	TAA1160-F-225	225	11	60	285

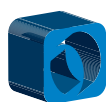

Fitbone TAA Intramedullary Nail Types

Part #	FITBONE TAA variants	Initial total length (mm)	Diameter (mm)	Stroke (mm)	Max Total length after distraction (mm)
--------	----------------------	---------------------------	---------------	-------------	---

Femur Variants

60001404	TAA1180-F-245	245	11	80	325
----------	---------------	-----	----	----	-----

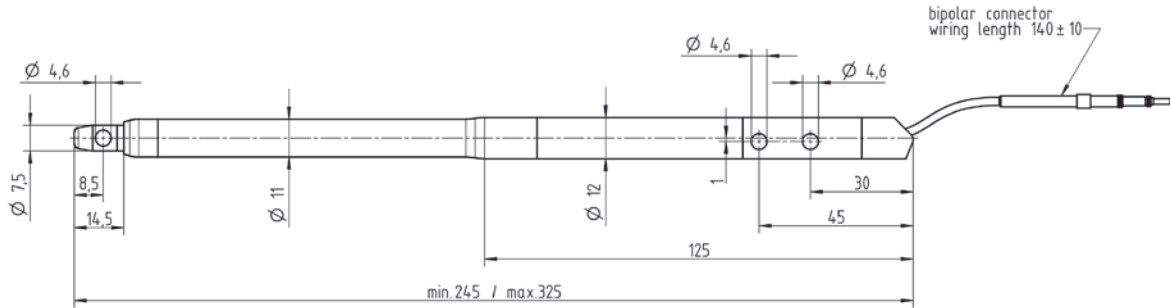

60001422	TAA1380-F-245	245	13	80	325
----------	---------------	-----	----	----	-----

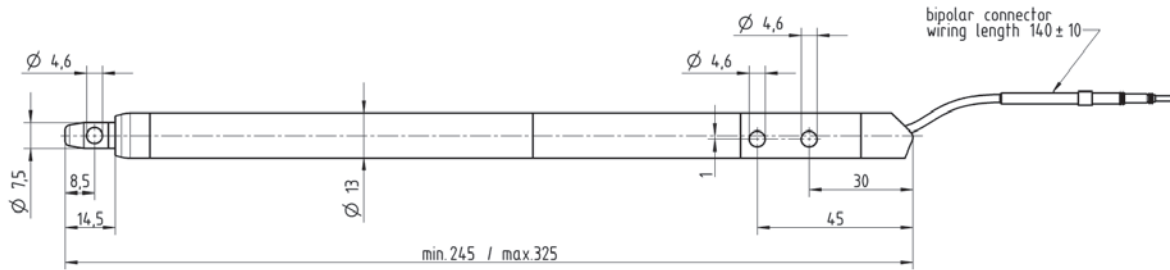

Part #	FITBONE TAA variants	Initial total length (mm)	Diameter (mm)	Stroke (mm)	Max Total length after distraction (mm)
--------	----------------------	---------------------------	---------------	-------------	---

Tibia Variants

60001928	TAA0940-T-200	200	9	40	240
----------	---------------	-----	---	----	-----

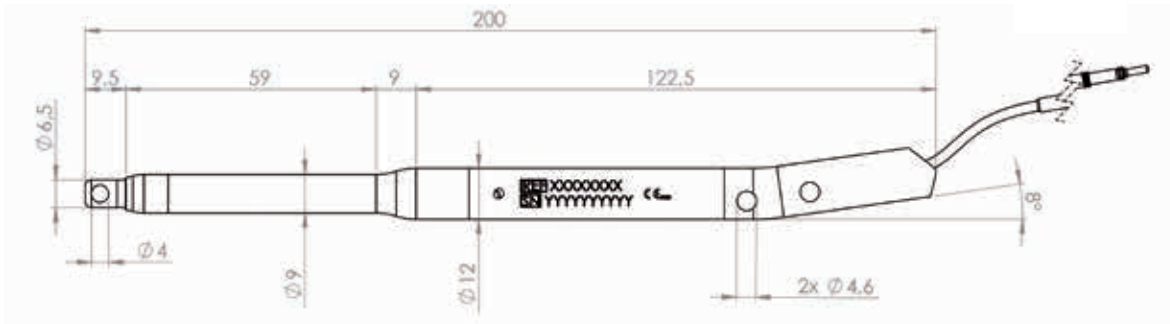

60001856	TAA0960-T-220	220	9	60	280
----------	---------------	-----	---	----	-----

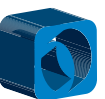
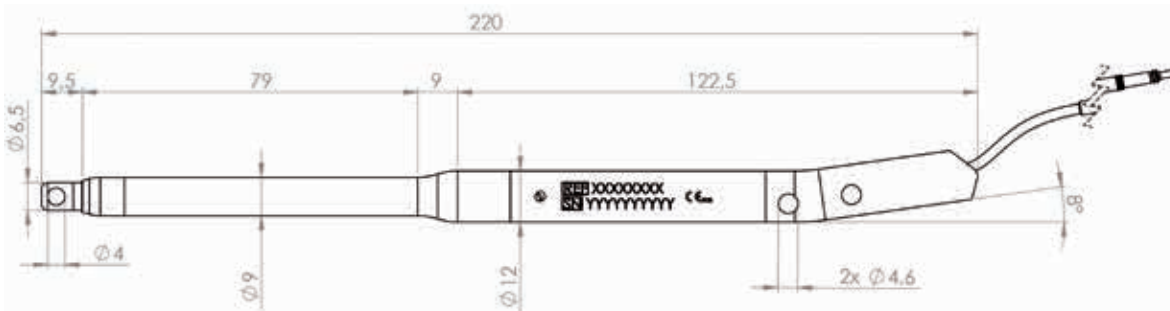





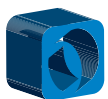



Fitbone TAA Intramedullary Nail Types

Part #	FITBONE TAA variants	Initial total length (mm)	Diameter (mm)	Stroke (mm)	Max Total length after distraction (mm)
Tibia Variants					
60001501	TAA1140-T-205	205	11	40	245
60001445	TAA1160-T-225	225	11	60	285
60001348	TAA1180-T-245	245	11	80	325



2. Fitbone TAA Additional Items

Part #	Description	Sterile	Further information	
60001780 (OUS & US)	Fitbone subcutaneous energy receiver	Yes	D26.5mm Height 4.5mm The receiver is implanted together with the nail and receives the energy from the transmitter at the control set.	
60001524 (Europe)	Fitbone Control Set for activation of intramedullary lengthening nail EU plug 230V	No	Control Set for distraction The control set transmits the energy via the receiver to the nail, which is necessary for the nail to distract. It is predominantly used by the patient for daily lengthening, but also intraoperatively to test the nail.	
60001989 (UK)	Fitbone Control Set for activation of intramedullary lengthening nail UK plug 230V	No	Control Set for distraction The control set transmits the energy via the receiver to the nail, which is necessary for the nail to distract. It is predominantly used by the patient for daily lengthening, but also intraoperatively to test the nail.	
60001939 (Europe)	Fitbone Retraction Control Set for retraction of intramedullary lengthening nail EU plug 230V	No	Retraction Control Set for retraction The control set for retraction transmits the energy via the receiver to the nail, which is necessary for the nail to retract. It is predominantly used by the surgeon in cases of medical emergency.	
60002023 (UK)	Fitbone Retraction Control Set for retraction of intramedullary lengthening nail UK plug 230V	No	Retraction Control Set for retraction The control set for retraction transmits the energy via the receiver to the nail, which is necessary for the nail to retract. It is predominantly used by the surgeon in cases of medical emergency.	
60001644	FITBONE Control Set for activation of intramedullary lengthening nail US plug 115V	No	Control set for distraction	
60001871	FITBONE Control Set for retraction of intramedullary lengthening nail	No	Control set for retraction	
60000676	Kawe stethoscope 06.10100.94	No	The stethoscope is the definitive method to check that the nail is functioning. The surgeon will use the stethoscope intraoperatively to check nail function and the patient will use it at home during regular lengthening.	

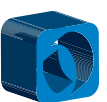

3. Fitbone Locking Screws (Part # 6991108)

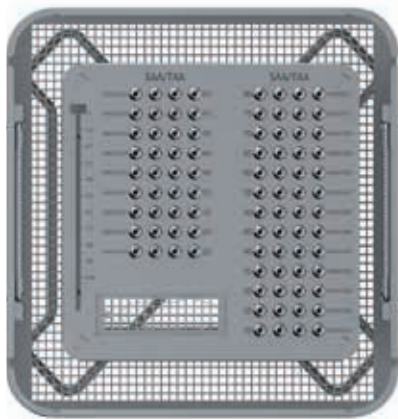



Material: Stainless Steel (AISI 316LVM)
 Short thread length: 3.7mm
 Long thread length: 6mm
 Thread internal diameter: 4.5mm
 Thread external diameter: 5.6mm



Material: Stainless Steel (AISI 316LVM)
 Short thread length: 3.4mm
 Thread internal diameter: 4.0mm
 Thread external diameter: 5.2mm

The 4mm locking screw caddy is included on the TAA09 Instrument Tray 6991967.

Screws	Part #	Description	Length (mm)	Diameter (mm)
Short thread 4.5mm				
	60000254	FITBONE locking screw D4.5 L20 short thread	20	4.5
	60000255	FITBONE locking screw D4.5 L25 short thread	25	4.5
	60000256	FITBONE locking screw D4.5 L30 short thread	30	4.5
	60000257	FITBONE locking screw D4.5 L35 short thread	35	4.5
	60000258	FITBONE locking screw D4.5 L40 short thread	40	4.5
	60000259	FITBONE locking screw D4.5 L45 short thread	45	4.5
	60000260	FITBONE locking screw D4.5 L50 short thread	50	4.5
Long thread 4.5mm				
	60000363	FITBONE locking screw D4.5 L20 long thread	20	4.5
	60000364	FITBONE locking screw D4.5 L25 long thread	25	4.5
	60000365	FITBONE locking screw D4.5 L30 long thread	30	4.5
	60000366	FITBONE locking screw D4.5 L35 long thread	35	4.5
	60000367	FITBONE locking screw D4.5 L40 long thread	40	4.5
	60000368	FITBONE locking screw D4.5 L45 long thread	45	4.5
	60000369	FITBONE locking screw D4.5 L50 long thread	50	4.5
	60000567	FITBONE locking screw D4.5 L55 long thread	55	4.5
	60000568	FITBONE locking screw D4.5 L60 long thread	60	4.5
	60000569	FITBONE locking screw D4.5 L65 long thread	65	4.5
	60000570	FITBONE locking screw D4.5 L70 long thread	70	4.5
	60000571	FITBONE locking screw D4.5 L75 long thread	75	4.5
	60000572	FITBONE locking screw D4.5 L80 long thread	80	4.5
	Short thread 4.0mm			
	60001828	FITBONE locking screw D4.0 L20 short thread	20	4.0
	60001829	FITBONE locking screw D4.0 L25 short thread	25	4.0
	60001830	FITBONE locking screw D4.0 L30 short thread	30	4.0
	60001831	FITBONE locking screw D4.0 L35 short thread	35	4.0

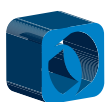

4. Disposable Products (For Single Patient Use)

Part #	Description	Sterile	Further information
99-941550 941550	Selfdrilling XCaliber cylindrical screw shaft D6mm thread 5mm L180/60QC or Selfdrilling XCaliber cylindrical screw shaft D6mm thread 5mm L180/60QC	Yes No	Shaft Diameter: 6mm Thread Diameter: 5mm Length: 180mm These cortical screws may be used during the FITBONE® surgery as a "joystick" for manipulating the distal fragment to achieve axial alignment or to ensure that no rotational deformity is created.
60001039	FITBONE Kirschner wire D3 L280	No	Diameter: 3mm Length: 280mm The K-wire is used to mark the entry point into the bone and will dictate the direction of reaming.
60001622	Biotronik torque wrench 395121	Yes	Key-width: (hexagon) 0.9mm This torque wrench is used for the tightening of screws that connect the receiver to the cable at the nail.
60001562	Lohmann & Rauscher raucodrape 15966 Endoscope camera protection cover	Yes	These camera protection covers are used to ensure the sterility of the transmitter and stethoscope during the intraoperative lengthening test at the end of the surgery.
60001370	B.Braun redon-drains catheter U2110800 Redon drainage	Yes	Length: 50cm Internal Diameter: 1.5mm External Diameter: 2.5mm This is a drainage catheter used for the lateral positioning of the cable through the 45° or 90° channel for the retrograde femur approach.
60002048	Cerclage wire	No	Diameter: 0.8mm Length: 1m The cerclage is used as a shuttle-relay to help place the drainage catheter through the 45deg/90deg channel during retrograde femur surgery.

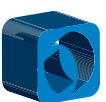

5. Fitbone Instruments

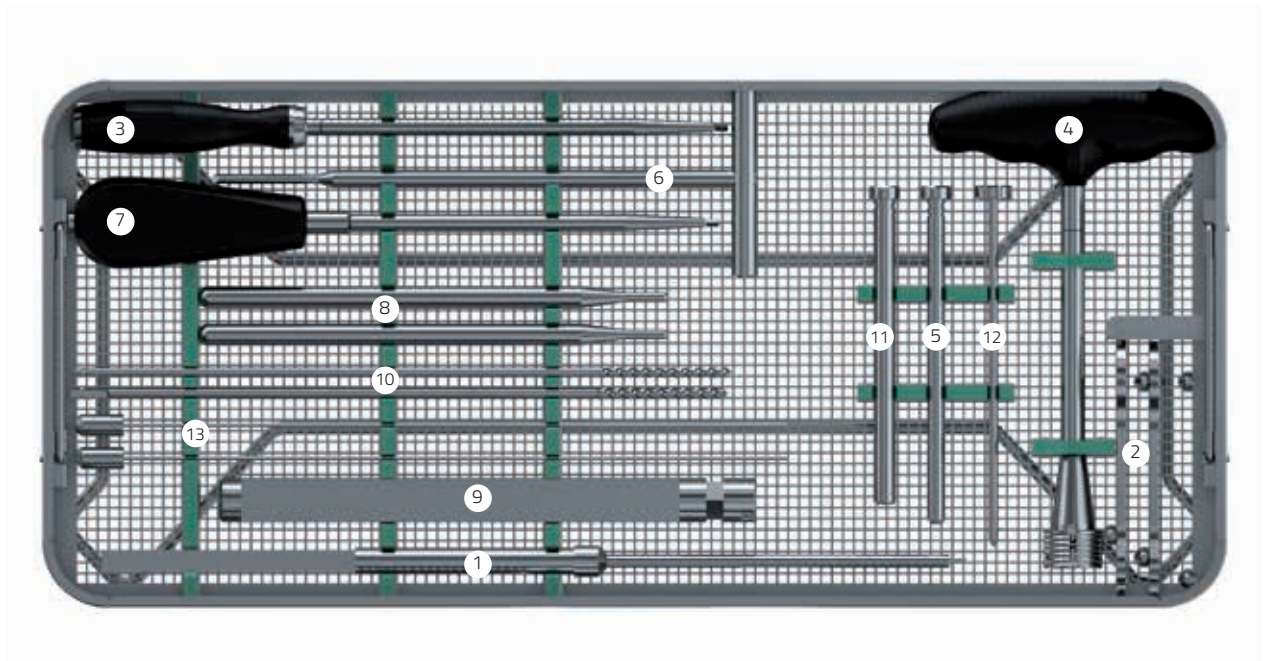

1

1 6990863 Fitbone General Tray

Can accommodate

1	1x	60000408	FITBONE DEPTH GAUGE
2	2x	60000689	Fitbone open end wrench SW14/17
3	1x	60000406	Fitbone screwdriver SW3.5 cannulated
4	1x	60000392	Fitbone T-handle
5	1x	60000400	Fitbone Drill sleeve D4.5 black
6	1x	60000405	Fitbone trocar D4.5 T-handle
7	1x	60000576	Fitbone screwdriver SW3.5
8	2x	60000688	Fitbone test pin D4.5
9	1x	60000317	Fitbone tapping tool
10	2x	60000398	Fitbone drill bit D4.5 L300
11	1x	60000402	Fitbone drill sleeve D8.0 green
12	1x	60000403	Fitbone trocar D4.5
13	2x	60000384	Fitbone screw holder M2 L325

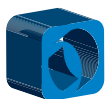

Fitbone Instruments

2

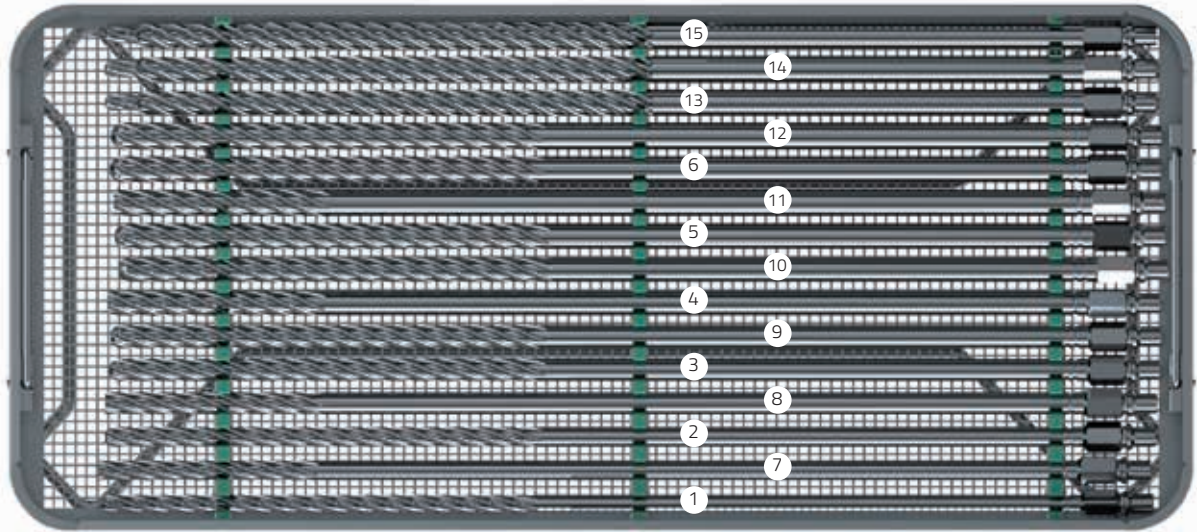

2
6990864
Fitbone Reamer Tray TAA L480

Can accommodate

1	1x 60000411	FITBONE REAMER D8.0 L200 L480 ROUNDED	10	1x 60000418	Fitbone reamer D11.0 L200 L480 rounded
2	1x 60000413	Fitbone reamer D9.0 L200 L480 rounded	11	1x 60000419	Fitbone reamer D12.0 L100 L480 forehead cutting
3	1x 60000415	Fitbone reamer D10.0 L200 L480 rounded	12	1x 60000716	Fitbone reamer D12.5 L200 L480 rounded
4	1x 60000417	Fitbone reamer D11.0 L100 L480 forehead cutting	13	1x 60001179	Fitbone step reamer TAA1180
5	1x 60000833	Fitbone reamer D11.5 L200 L480 rounded	14	1x 60001415	Fitbone step reamer TAA1160
6	1x 60000420	Fitbone reamer D12.0 L200 L480 rounded	15	1x 60001528	Fitbone step reamer TAA1140
7	1x 60000412	Fitbone reamer D9.0 L100 L480 forehead cutting			
8	1x 60000414	Fitbone reamer D10.0 L100 L480 forehead cutting			
9	1x 60000416	Fitbone reamer D10.5 L200 L480 rounded			

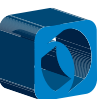

Fitbone Instruments

3

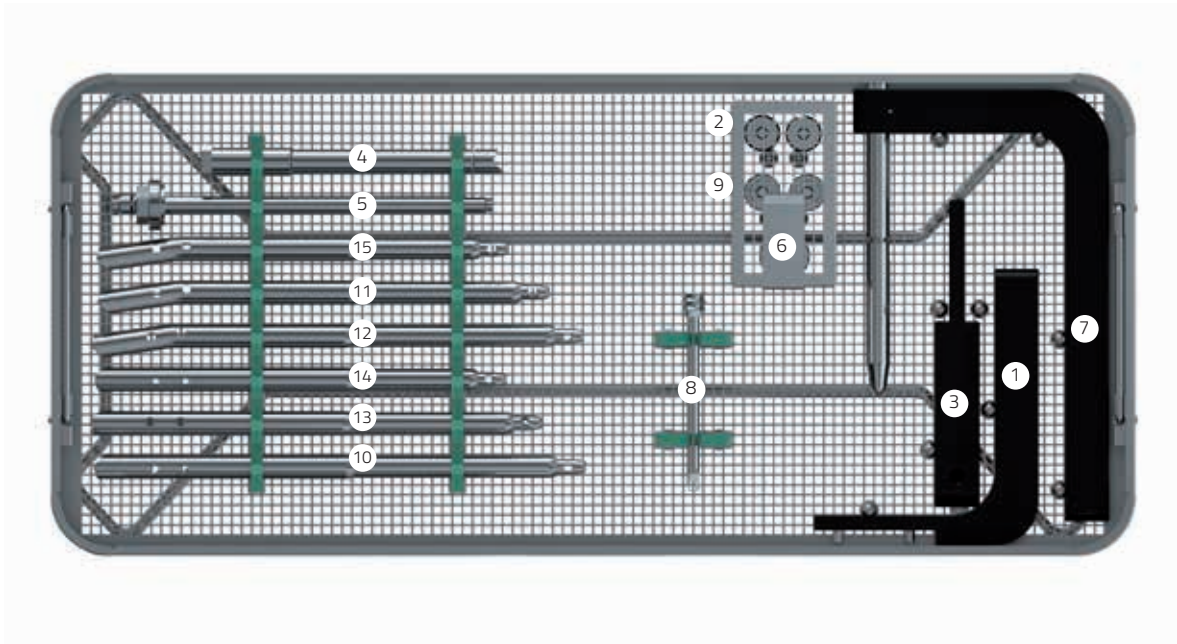

3

6990865

Fitbone Instrument Tray TAA

Can accommodate

1	1x	60001184	FITBONE OUTRIGGER TAA	13	1x	60001139	Fitbone dummy TAA1160-F-225
2	2x	60000175	Fitbone fastening bolt M6 L9	14	1x	60001248	Fitbone dummy TAA1140-F-205
3	1x	60001175	Fitbone drill guide TAA	15	1x	60001244	Fitbone dummy TAA1140-T-205
4	1x	60000218	Fitbone space holder TAA				
5	1x	60000310	Fitbone connection bolt TAA				
6	1x	60000219	Fitbone clamping nut TAA				
7	1x	60001439	Fitbone targeting device 45°/90°				
8	1x	60001307	Fitbone wire catcher 90°				
9	2x	60000003	Fitbone setscrew				
10	1x	60000822	Fitbone dummy TAA1180-F-245				
11	1x	60000832	Fitbone dummy TAA1160-T-225				
12	1x	60001495	Fitbone dummy TAA1180-T-245				

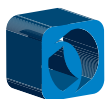

Fitbone Instruments

4

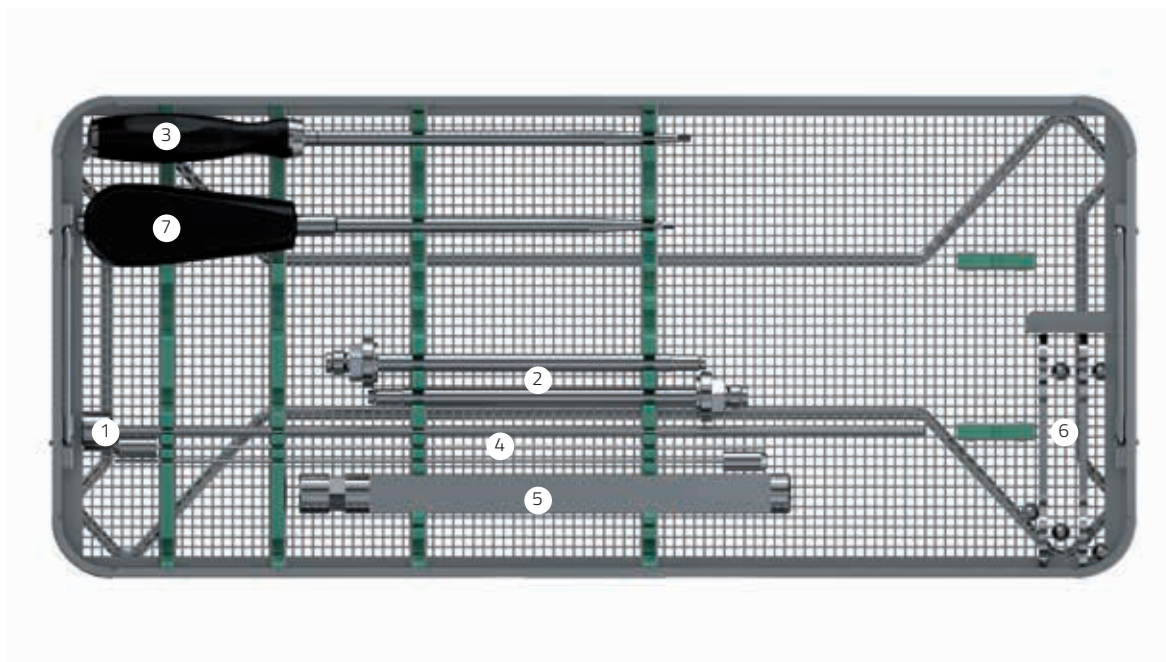

4

6990875

Fitbone Extraction Tray

Can accommodate

1	1x	60000513	FITBONE FASTENING BOLT M4 L400
2	2x	60000310	Fitbone connection bolt TAA
3	1x	60000406	Fitbone screwdriver SW3.5 cannulated
4	2x	60000384	Fitbone screw holder M2 L325
5	1x	60000317	Fitbone tapping tool
6	2x	60000689	Fitbone open end wrench SW14/17
7	1x	60000576	Fitbone screwdriver SW3.5

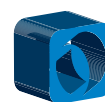

Fitbone Instruments

5

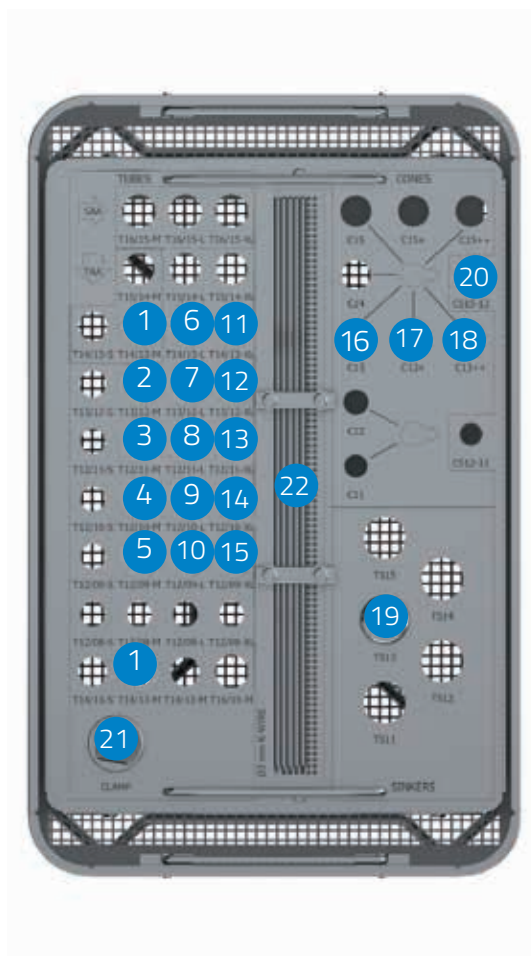

5 6991040 Fitbone Tube System TAA

Can accommodate

1	2x	60001014	FITBONE TUBE T14/13-M	16	1x	60001028	Fitbone cone C13
2	1x	60001015	Fitbone tube T13-12-M	17	1x	60001029	Fitbone cone C13+
3	1x	60001016	Fitbone tube T12/11-M	18	1x	60001030	Fitbone cone C13++
4	1x	60001017	Fitbone tube T12/10-M	19	1x	60001033	Fitbone tube-sinker TS13
5	1x	60001018	Fitbone tube T12/09-M	20	1x	60001036	Fitbone cone-sinker CS15-13
6	1x	60001058	Fitbone tube T14/13-L	21	1x	60001038	Fitbone clamp
7	1x	60001055	Fitbone tube T13/12-L	22	6x	60001039	Fitbone Kirschner wire D3 L280
8	1x	60001020	Fitbone tube T12/11-L				
9	1x	60001021	Fitbone tube T12/10-L				
10	1x	60001022	Fitbone tube T12/09-L				
11	1x	60001054	Fitbone tube T14/13-XL				
12	1x	60001059	Fitbone tube T13/12-XL				
13	1x	60001024	Fitbone tube T12/11-XL				
14	1x	60001025	Fitbone tube T12/10-XL				
15	1x	60001026	Fitbone tube T12/09-XL				

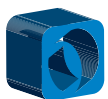

Fitbone Instruments

6

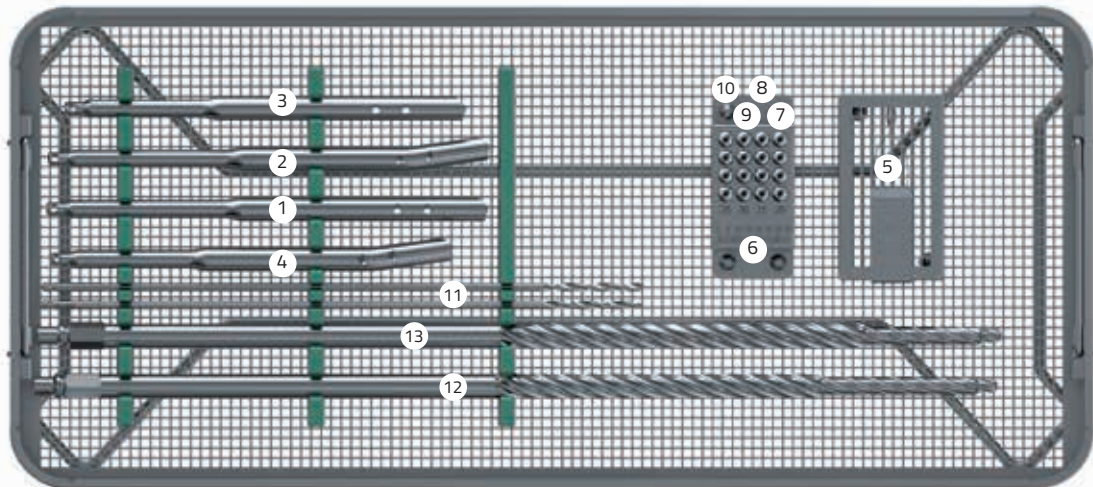

6

6991967

Fitbone Tray TAA09

Only required for implantation of TAA09 nails

Can accommodate

1	1x	60001854	DUMMY TAA0960-F-220
2	1x	60001855	Dummy TAA0960-T-220
3	1x	60001925	Dummy TAA0940-F-200
4	1x	60001927	Dummy TAA0940-T-200
5	1x	60000410	Pliers for screws
6	1x	60001863	Screw Box
7	4x	60001828	Locking Screw D4 L20 short
8	4x	60001829	Locking Screw D4 L25 short
9	4x	60001830	Locking Screw D4 L30 short
10	4x	60001831	Locking Screw D4 L35 short
11	2x	60001848	Drill 4mm
12	1x	60001849	Step Reamer TAA0960
13	1x	60001938	Step Reamer TAA0940

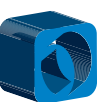

Fitbone Instruments

7

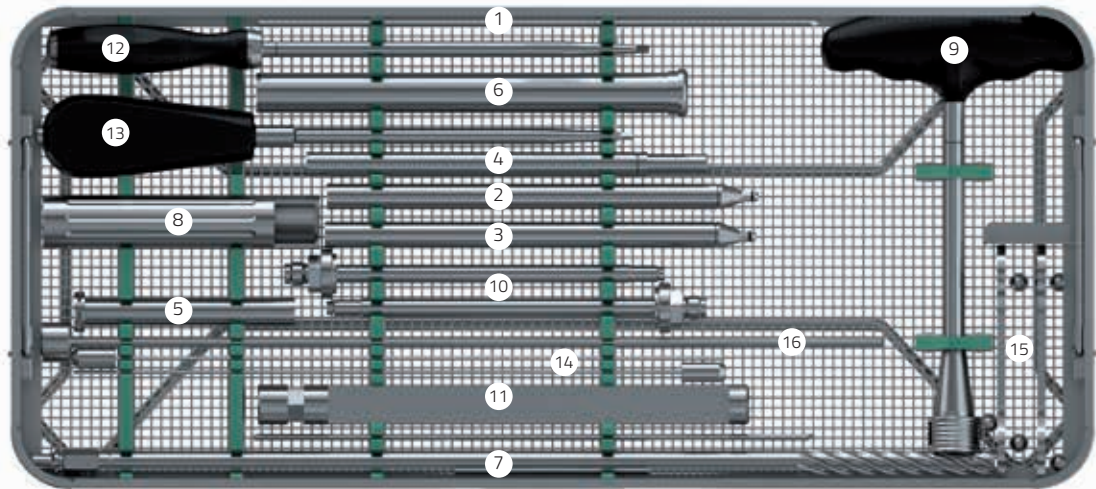

7

6992062

Fitbone Extraction Tray TAA09 and TAA11

Only required for explantation of TAA09 and TAA11 nails

Can accommodate

1	1x	60001039	FITBONE CONE K-WIRE D3MM L280	13	1x	60000576	FITBONE screwdriver SW3.5
2	1x	60001028	FITBONE cone C13	14	2x	60000384	FITBONE screw holder M2 L325
3	1x	60001029 or 1030	FITBONE cone C13+ or C13++	15	2x	60000689	FITBONE open end wrench SW14/17
4	1x	60001036	FITBONE cone-sinker CS 15-13	16	1x	60000513	FITBONE fastening bolt M4 L400
5	1x	60001014	FITBONE tube T 14/13-M				
6	1x	60001033	FITBONE tube sinker TS13				
7	1x	60000419	FITBONE reamer D12mm forehead cutting				
8	1x	60001038	FITBONE clamp				
9	1x	60000392	FITBONE T-handle				
10	2x	60000310	FITBONE connection bolt taa				
11	1x	60000317	FITBONE tapping tool				
12	1x	60000406	FITBONE screwdriver SW3.5 cannulated				

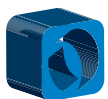

Fitbone Instruments

8

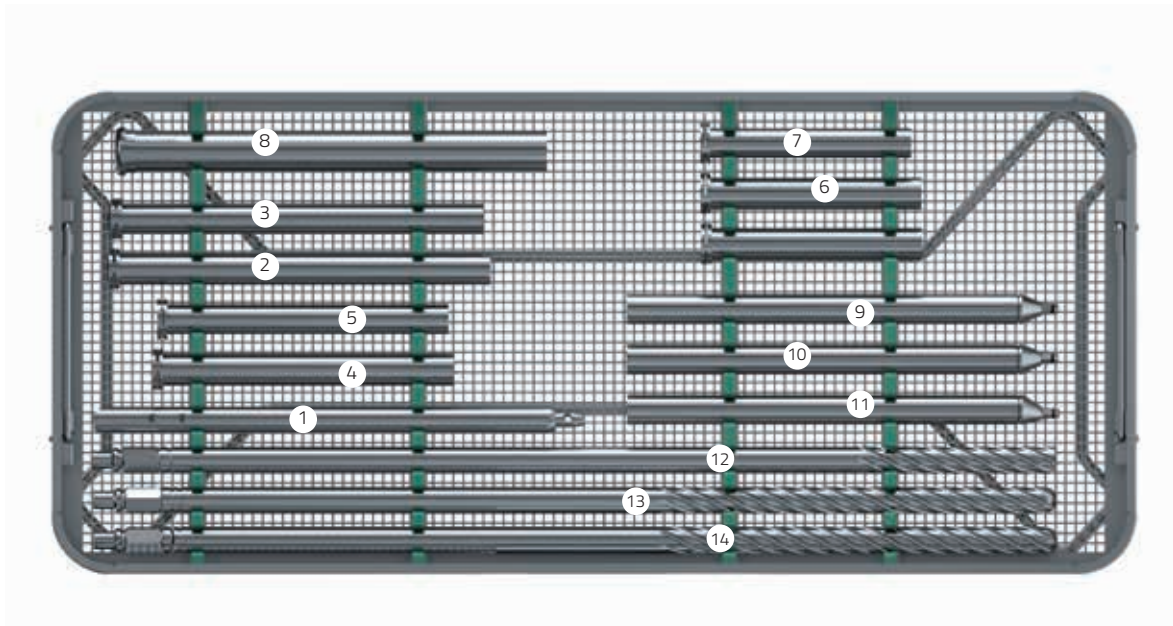

8

6992059

Fitbone Instrument Tray TAA13

Only required for implantation of TAA13 nails

Can accommodate

1	1x	60001623	FITBONE DUMMY TAA1380-F-245
2	1x	60001056	FITBONE tube T16/15-XL
3	1x	60001057	FITBONE tube T15/14-XL
4	1x	60001052	FITBONE tube T16/15-L
5	1x	60001053	FITBONE tube T15/14-L
6	2x	60001050	FITBONE tube T16/15-M
7	1x	60001051	FITBONE tube T15/14-M
8	1x	60001064	FITBONE tube-sinker TS15
9	1x	60001060	FITBONE cone C15
10	1x	60001061	FITBONE cone C15+
11	1x	60001062	FITBONE cone C15++
12	1x	60000421	FITBONE reamer D13.0 L100 L480 forehead cutting

13

1x **60000422** FITBONE reamer D13.0
L200 L480 rounded

14

1x **60000423** FITBONE reamer D13.5
L200 L480 rounded

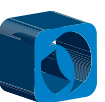

9

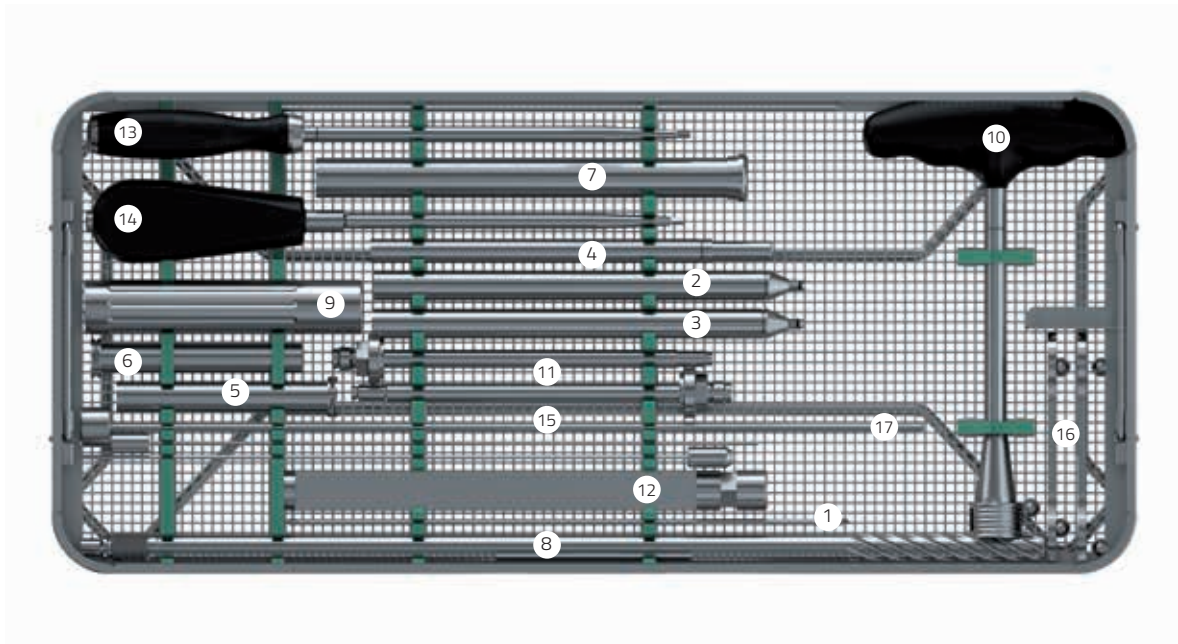

9

6992065

Fitbone Extraction Tray TAA13

Only required for explantation of TAA13 nails

Can accommodate

1	1x	60001039	FITBONE K-WIRE D3MM L280	14	1x	60000576	FITBONE screwdriver SW3.5
2	1x	60001060	FITBONE cone C15	15	2x	60000384	FITBONE screw holder M2 L325
3	1x	60001061	FITBONE cone C15+	16	2x	60000689	FITBONE open end wrench SW14/17
4	1x	60001036	FITBONE cone- sinker CS 15-13	17	1x	60000513	FITBONE fastening bolt M4 L400
5	1x	60001050	FITBONE tube T 16/15-M				
6	1x	60001051	FITBONE tube T 15/14-M				
7	1x	60001064	FITBONE tube-sinker TS15				
8	1x	60000421	FITBONE reamer D13mm L100 L480 forehead cutting				
9	1x	60001038	FITBONE clamp				
10	1x	60000392	FITBONE T-handle				
11	2x	60000310	FITBONE connection bolt TAA				
12	1x	60000317	FITBONE tapping tool				
13	1x	60000406	FITBONE screwdriver SW3.5 cannulated				

