

OPERATIVE TECHNIQUE

Ankle

Hindfoot Nailing System™

Ankle Hindfoot Nailing (AHN) System



Ankle

Hindfoot Nailing System™

Table of Contents

1	Introduction
2	Features and benefits
5	Ordering information
9	Patient selection
9	Preoperative planning
11	Surgical approach
28	Nail removal

Orthofix wishes to recognize William Terrell, M.D., for his significant contributions toward the development of this technique.

The organization wishes to recognize Matthew Deorio, M.D., for his contributions toward the editorial review.

Proper surgical procedure is the responsibility of the medical professional. Operative techniques are furnished as an informative guideline. Each surgeon must evaluate the appropriateness of a technique based on his or her personal medical credentials and experience. Please refer to the 'Instructions for Use' supplied with the product for specific information on indications for use, contraindications, warnings, precautions, adverse reactions and sterilization.

INTRODUCTION

INDICATIONS

The Orthofix Ankle Hindfoot Nailing System is intended to facilitate tibiotalar calcaneal arthrodesis (fusion). Specific indications include:

1. Avascular necrosis of the talus
2. Failed total ankle arthroplasty
3. Trauma (malunited tibial pilon fracture)
4. Severe deformity or instability as a result of talipes equinovarus, cerebral vascular accident, paralysis or other neuromuscular disease
5. Revision ankle arthrodesis
6. Neuroarthropathy
7. Rheumatoid arthritis
8. Osteoarthritis
9. Pseudoarthrosis
10. Post-traumatic arthrosis
11. Previously infected arthrosis
12. Charcot foot
13. Severe endstage degenerative arthritis
14. Severe defects after tumor resection
15. Pantalar arthrodesis.

DESCRIPTION

The Orthofix Ankle Hindfoot Nailing System (AHN) comprises a variety of implantable intramedullary nails with respective locking end caps and locking screws manufactured from titanium alloy (Ti6Al4V) which are intended to facilitate tibiotalar calcaneal arthrodesis (fusion). The system also includes instrumentation required for implantation and explantation of the implants.

CONTRAINDICATIONS

1. Active or latent infection in the affected area
2. General medical conditions including: impaired blood supply, pulmonary insufficiency (i.e. ARDS, fat embolism) and insufficient quantity or quality of bone
3. Patients who are unwilling or incapable of following post-operative care instructions
4. Suspected or documented metal allergy or intolerance
5. Severe longitudinal deformity
6. Insufficient plantar heel pad
7. Situations where an isolated ankle or subtalar fusion can be performed
8. Dysvascular limb

GENERAL WARNINGS

These implants are not intended to replace normal healthy bone. Loads produced by weight bearing and activity levels will dictate the longevity of the implant. The patient should understand that stress on an implant can be produced without actual weight bearing. In the absence of solid bony union, the weight of the limb alone, muscular forces associated with moving a limb, or repeated stresses of apparent relatively small magnitude, can result in failure of the implant.

Therefore, the patient should follow the postoperative instructions given by the surgeon.

The product is intended for professional use only. Surgeons who supervise the use of the product must have full awareness of orthopedic fixation procedures and should have received adequate training in the use of the product. Prior to surgery, surgeons should be familiar with the devices, instruments and surgical procedure, including the application and removal. Detailed operative technique guidance is available on request; please contact Orthofix or your local distributor.

1. Processing and re-processing of instrumentation should be performed according to the dedicated leaflet PQ AHR.
2. Ensure that all components needed for the operation are available and fully functional in the operating theater before surgery. Perform targeting and functional control before the insertion of the nail as well to avoid nail damage during drilling operation.
3. Implants, nail end caps, locking screws as well as certain parts of the instrumentation (where indicated on the label) are for single use only and must never be reused. If any implant has to come into contact with any body fluid it should be considered to have been used.
4. Smoking, chronic steroid use and the use of other anti-inflammatory drugs have been shown to affect bone healing and could potentially have an adverse effect on bone repair during fracture healing.
5. Components of this device are not approved for screw attachment to the posterior elements of the cervical, thoracic, or lumbar spine.
6. Remove after fracture has healed. Implants can loosen, fracture, corrode, migrate, or cause pain. If an implant remains implanted after complete healing, the implant may cause stress shielding, which may increase the risk of refracture in an active patient. The surgeon should weigh the risks versus benefits when deciding whether to remove the implant. Adequate postoperative management to avoid refracture should follow implant removal.
7. MRI safety not tested.

POSSIBLE ADVERSE EFFECTS

1. Loosening, bending or breakage of implanted components
2. Loss of anatomic positioning with malunion
3. Scar formation possibly causing pain and/or neurological compromises around nerves
4. Intrinsic risks associated with anesthesia and surgery. Hemorrhage, hematoma, seroma, embolism, edema, stroke, excessive bleeding, phlebitis, wound or bone necrosis, wound infection or damage to blood vessels or nerves
5. Non-union or delayed union, which may lead to implant breakage
6. Metal sensitivity, or allergic reaction to a foreign body
7. Pain, discomfort, or abnormal sensations due to the presence of the device

INSTRUCTIONS FOR USE (IFU)

See actual package insert for instructions for use.

FEATURES AND BENEFITS

Nails

- Cannulated
- Titanium
- Lengths: 150, 200, 250, 300mm
- Diameters: 10, 11, 12mm
- Distal Diameter: 12mm
- Blue: 150, 250, 300mm
- Green: 200mm
- Talar hole allows for
 - 7mm of internal tibio-talar compression
 - screw can be locked within any position of the slot
- Tibial screws offer static and dynamic options
- Long Nails (250, 300mm) include (2) sets of tibial screw holes. This provides the freedom to utilize the targeting assembly or free-hand per surgeon discretion.

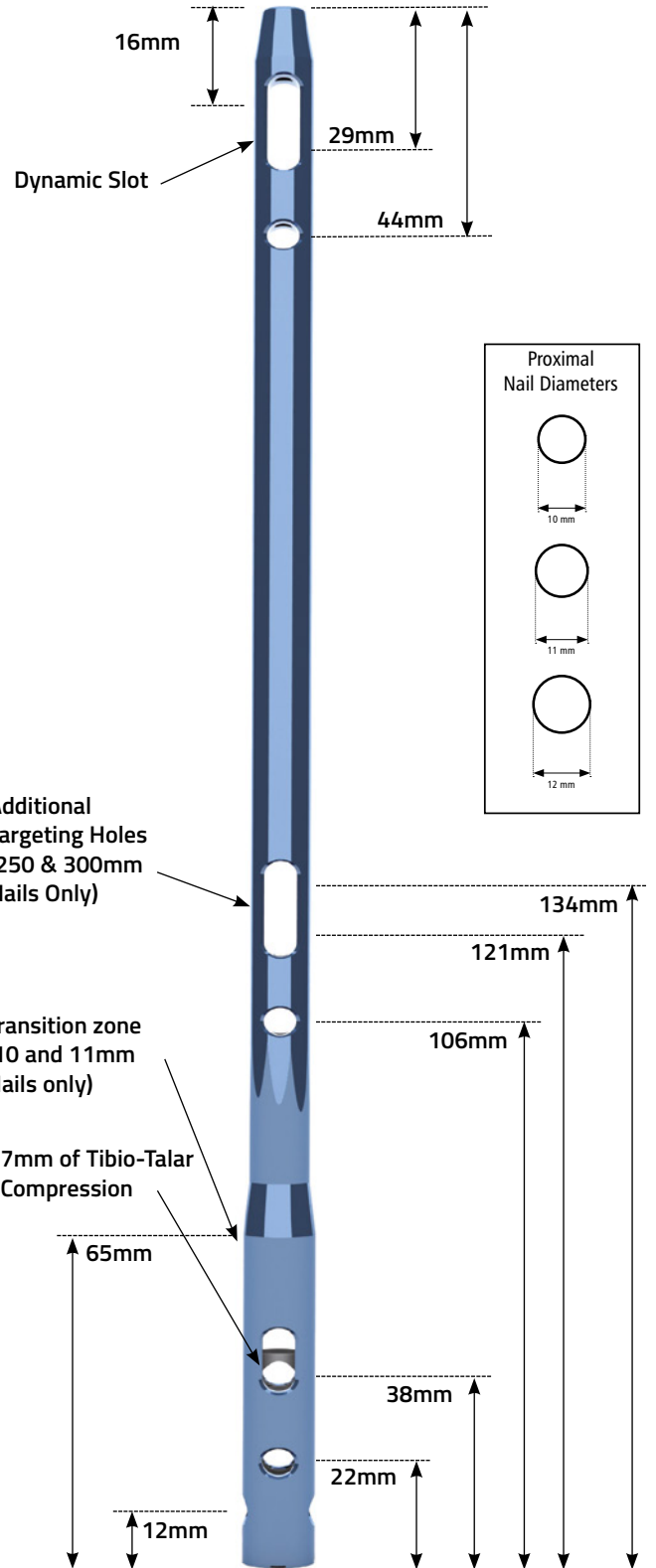
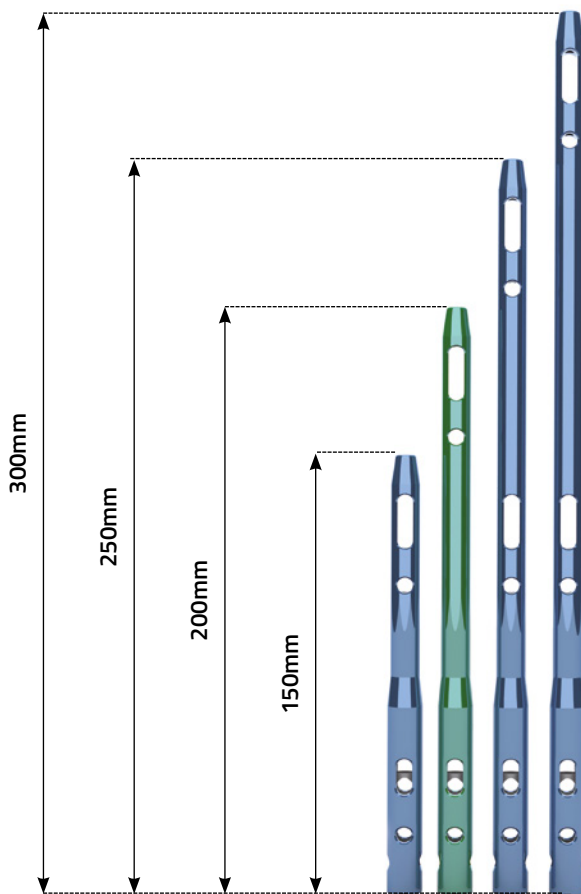

LOCKING SCREWS

Low Profile Screws (magenta) (T774xxx)

- 5mm Diameter
- 4.3mm Core Diameter
- 20 - 120mm. See table on Page 5

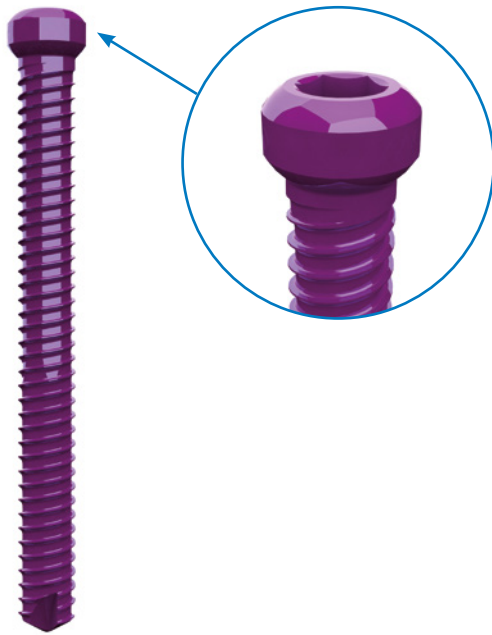

Threaded Head Screws (dark blue) (T775xxx)

- 5mm Diameter
- 4.3mm Core Diameter
- 60 - 120mm; 5mm increments
- Designed for the calcaneus. The threaded head sinks into the bone, substantially reducing risk of posterior prominence

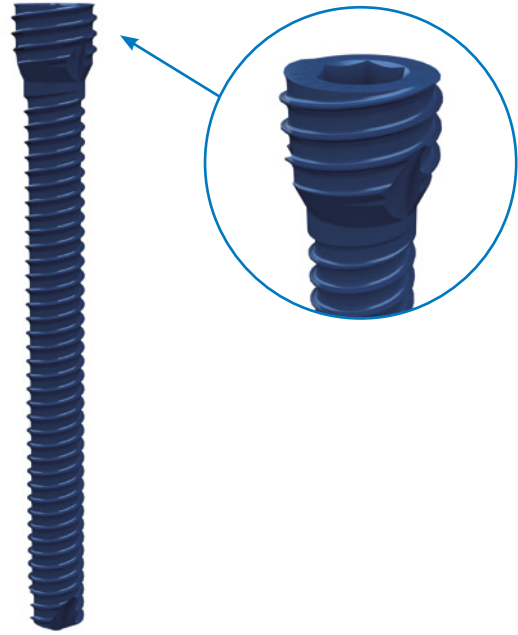

Locking End Cap

- Lengths of 0, 5, 10mm
- Cannulated
- Functions to lock Calcaneal Screws

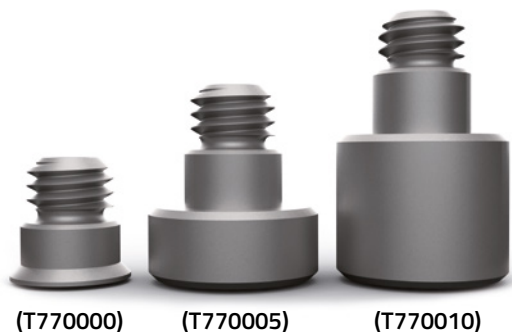

TARGETING ASSEMBLY

- Precise targeting available for tibia in all lengths
- Radiolucent
- Proximal Targeting Arm is fixed; Distal Targeting Arm locks in 90 degree increments – helping to ensure a secure platform throughout the procedure

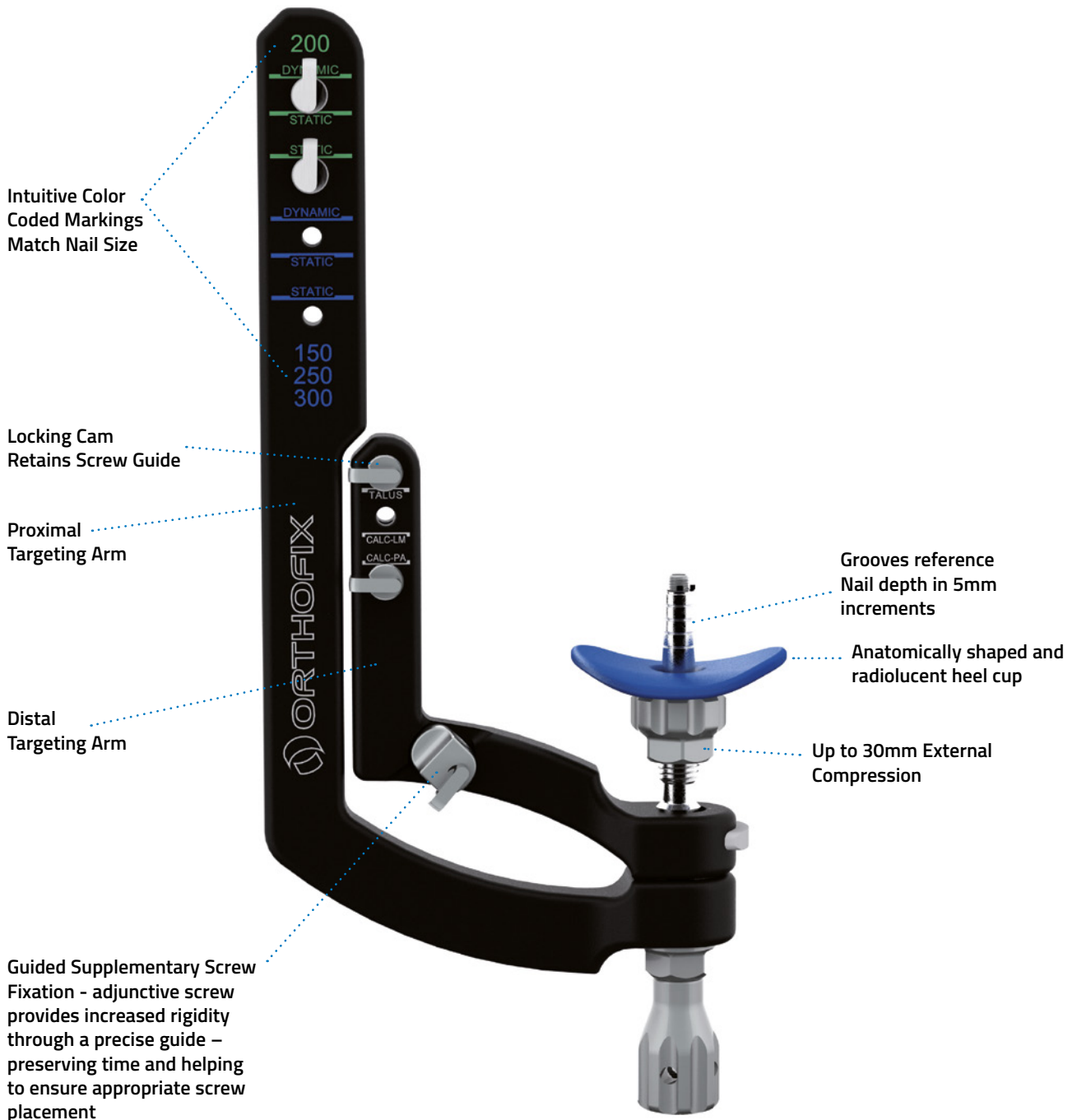

ORDERING INFORMATION

Titanium Ankle Hindfoot Nail

99-T77015	Ø 10mm L 150mm	Cannulated
99-T77020	Ø 10mm L 200mm	Cannulated
99-T77025	Ø 10mm L 250mm	Cannulated
99-T77030	Ø 10mm L 300mm	Cannulated
99-T77115	Ø 11mm L 150mm	Cannulated
99-T77120	Ø 11mm L 200mm	Cannulated
99-T77125	Ø 11mm L 250mm	Cannulated
99-T77130	Ø 11mm L 300mm	Cannulated
99-T77215	Ø 12mm L 150mm	Cannulated
99-T77220	Ø 12mm L 200mm	Cannulated
99-T77225	Ø 12mm L 250mm	Cannulated
99-T77230	Ø 12mm L 300mm	Cannulated

Threaded Head Screws D 5mm

99-T775060	L 60mm
99-T775065	L 65mm
99-T775070	L 70mm
99-T775075	L 75mm
99-T775080	L 80mm
99-T775085	L 85mm
99-T775090	L 90mm
99-T775095	L 95mm
99-T775100	L 100mm
99-T775105	L 105mm
99-T775110	L 110mm
99-T775115	L 115mm
99-T775120	L 120mm

Locking End Cap

99-T770000	L 0mm
99-T770005	L 5mm
99-T770010	L 10mm

Sterile Packaged Instrumentation

99-177281	3.0mm x 800mm Ball Tip Guide Wire
99-177282	2.5mm x 800mm Guide Wire

Low Profile Screws D 5mm

99-T774020	L 20mm
99-T774022	L 22.5mm
99-T774025	L 25mm
99-T774027	L 27.5mm
99-T774030	L 30mm
99-T774032	L 32.5mm
99-T774035	L 35mm
99-T774037	L 37.5mm
99-T774040	L 40mm
99-T774045	L 45mm
99-T774050	L 50mm
99-T774055	L 55mm
99-T774060	L 60mm
99-T774065	L 65mm
99-T774070	L 70mm
99-T774075	L 75mm
99-T774080	L 80mm
99-T774085	L 85mm
99-T774090	L 90mm
99-T774095	L 95mm
99-T774100	L 100mm
99-T774105	L 105mm
99-T774110	L 110mm
99-T774115	L 115mm
99-T774120	L 120mm

Flexible Reamer Set 172001C (US Market) 172001 (Intl Market)

Consisting of:

1x172991	Flexible Reamer System Box, empty
1x172090	Modular Reamer Head Ø 9mm
1x172095	Reamer Head Ø 9.5mm
1x172100	Reamer Head Ø 10mm
1x172105	Reamer Head Ø 10.5mm
1x172110	Reamer Head Ø 11mm
1x172115	Reamer Head Ø 11.5mm
1x172120	Reamer Head Ø 12mm
1x172125	Reamer Head Ø 12.5mm
1x172130	Reamer Head Ø 13mm
1x172135	Reamer Head Ø 13.5mm
1x172140	Reamer Head Ø 14mm
1x172145	Reamer Head Ø 14.5mm
1x172150	Reamer Head Ø 15mm
1x172155	Reamer Head Ø 15.5mm
1x172160	Reamer Head Ø 16mm
1x172165	Reamer Head Ø 16.5mm
1x172170	Reamer Head Ø 17mm
2x172200	Flexible Reamer Shafts
1x172080	Monobloc Flexible Reamer Ø 8mm
1x172085	Monobloc Flexible Reamer Ø 8.5mm
1x172210	Flexible Shaft Adapter
1x17955	Universal Chuck with T-Handle
1x172220	Soft Tissue Protector

CLEANING, DISINFECTION, STERILIZATION AND MAINTENANCE OF INSTRUMENTATION

Orthofix supplies the Ankle Hindfoot Nail, locking screws and locking end caps in a STERILE package, while the instruments are supplied NON STERILE except the 800mm Guide Wires, which are supplied STERILE. Please check the sterility of each device on the product label.

The surgeon must check that the package has not been damaged and has not expired. The instruments are supplied in a non-sterile state and therefore must be cleaned before use, as described for new products. The whole cleaning, disinfection and sterilization cycle must be followed before each use, as described in the instructions for use PQ AHR (Instructions for the Safe Processing of the Orthofix Ankle Hindfoot Nailing System). The instruments used during the operation should be cleaned, disinfected and re-sterilized in an autoclave, as described in the instructions for use PQ AHR.

Disassemble all instruments for thorough cleaning and disinfection prior to sterilization.

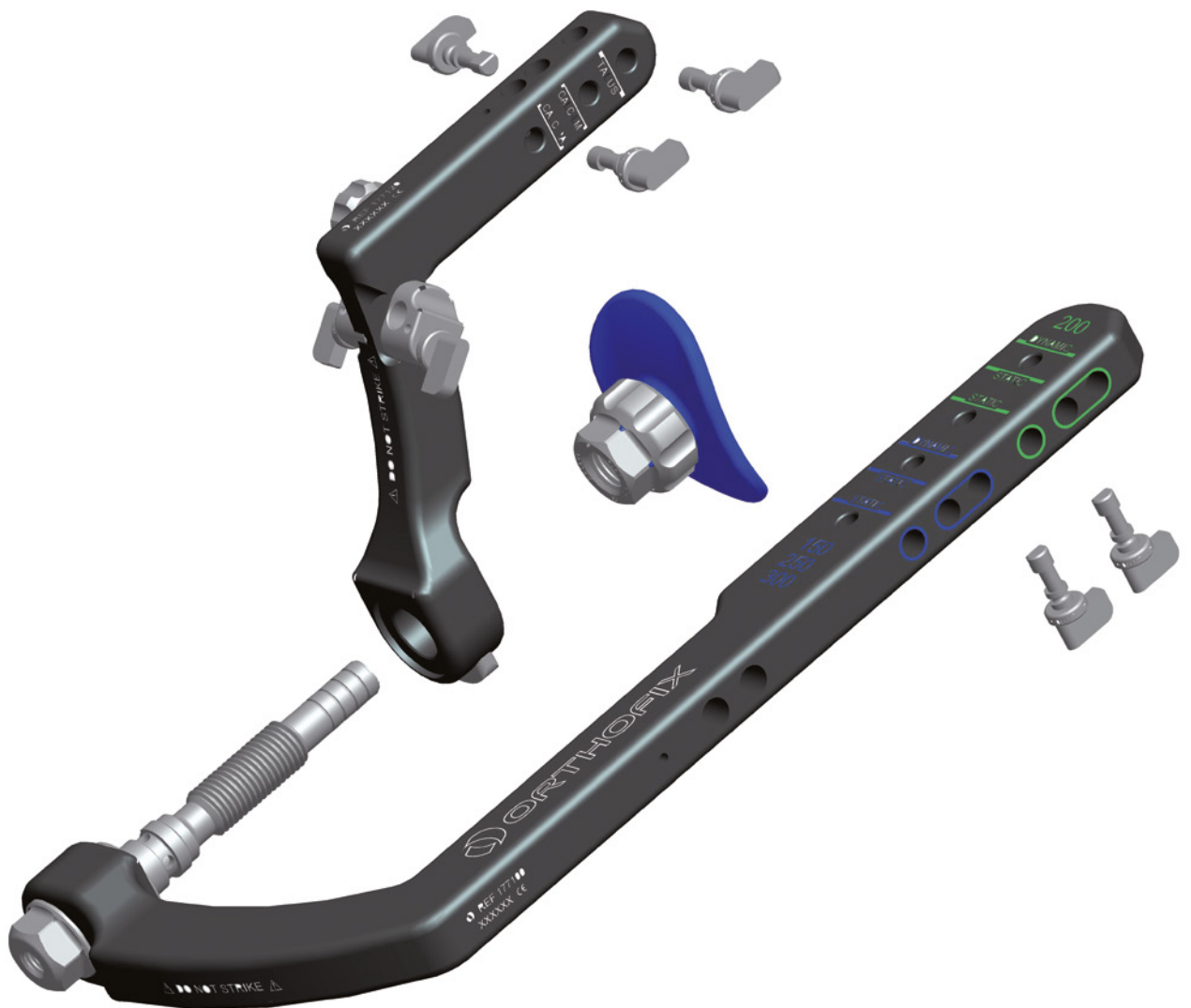

Insertion Instruments Tray empty (177991)
Insertion Instruments Tray full (450437C for US Market)

INSTRUMENTS TRAY

Part #	Description
Upper Tray	
177380	1 Slotted Mallet
177340	2 Ratcheting Straight Handle
177350	3 Ratcheting T-Handle
177301	4 Locking Driver
177305	5 Compression Driver
177304	6 Short Depth Gauge

Part #	Description
Upper Tray	
177300	7 Long Depth Gauge
177211	8 Screw Guide
177212	9 Trocar
177213	10 4.3mm Drill Guide
177320	11 3.5mm Hex Screw Driver

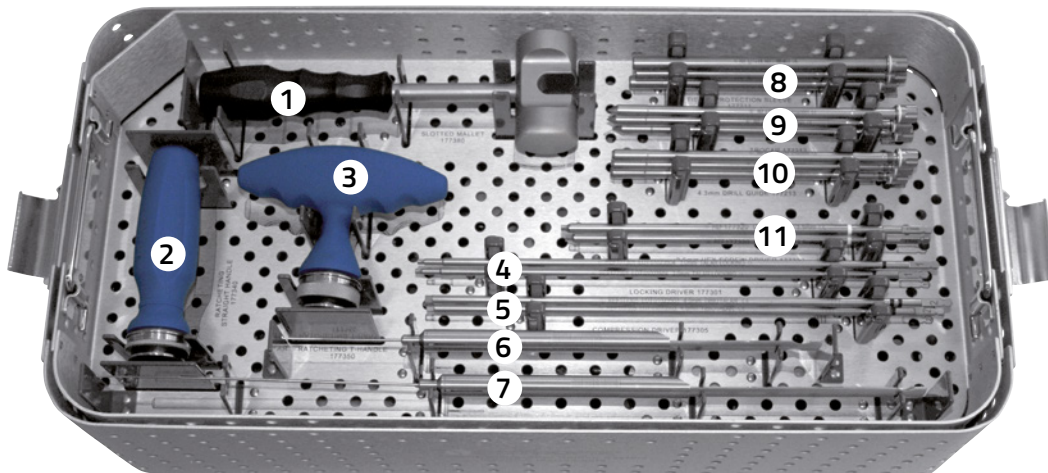

Part #	Description
Lower Tray	
177100	1 Proximal Targeting Arm
177120	2 Distal Targeting Arm
177026	3 Locking Cam
177125	4 Heel Cup

Part #	Description
Lower Tray	
177385	5 Slotted Mallet Adaptor
177071	6 Impactor
177110	7 Nail Attachment Rod
177072	8 24mm Wrench

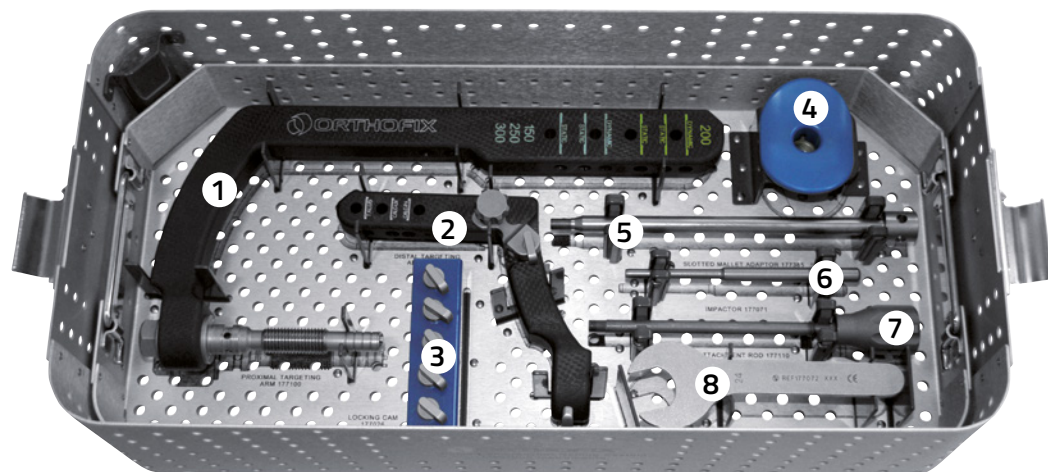

Drills and Reamers Tray empty (177992)
Drills and Reamers Tray full (450438C for US Market)

INSTRUMENTS TRAY

Part #	Description
Upper Tray	
177291	1 Reaming Wire Pusher
177287	2 7mm Entry Drill
177288	3 9mm Entry Drill
177289	4 13mm Entry Reamer
17353	5 Guide Wire Exchange Tube
177286	6 4.3mm Calibrated Drill
177275	7 X-Ray Ruler

Part #	Description
Upper Tray	
177215	8 7mm Bushing
177216	9 9mm Bushing
177290	10 3.2mm x 400mm Entry Guide Wire
177284	11 4.3mm Freehand Drill
177292	12 Countersink
177283	13 6.1mm Drill for Threaded Head Screw
177302	14 Entry Tissue Sleeve

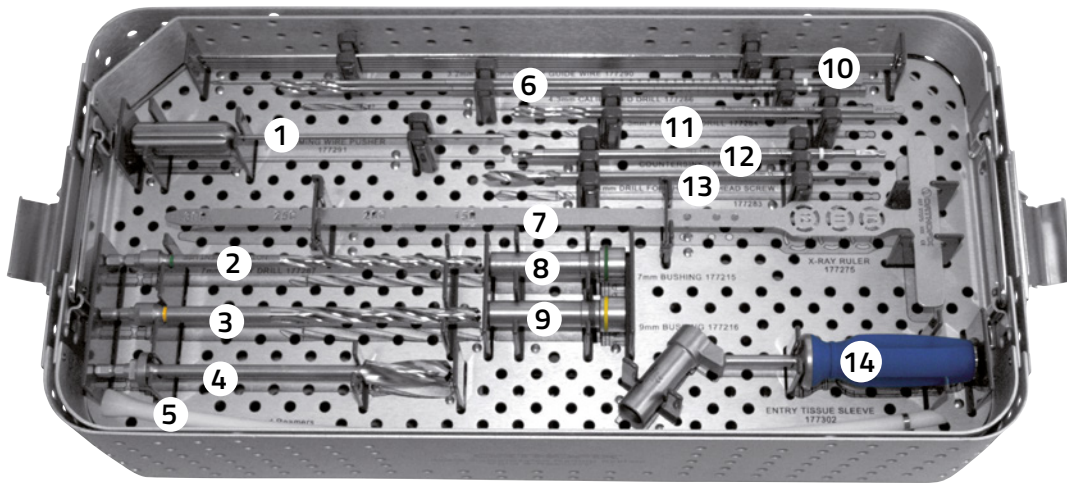

Part #	Description
Lower Tray	
177387	1 1.8 x 350mm Guide Wire
177072	2 24mm Wrench
GP510CE	3 3.5mm Cannulated Hex Driver

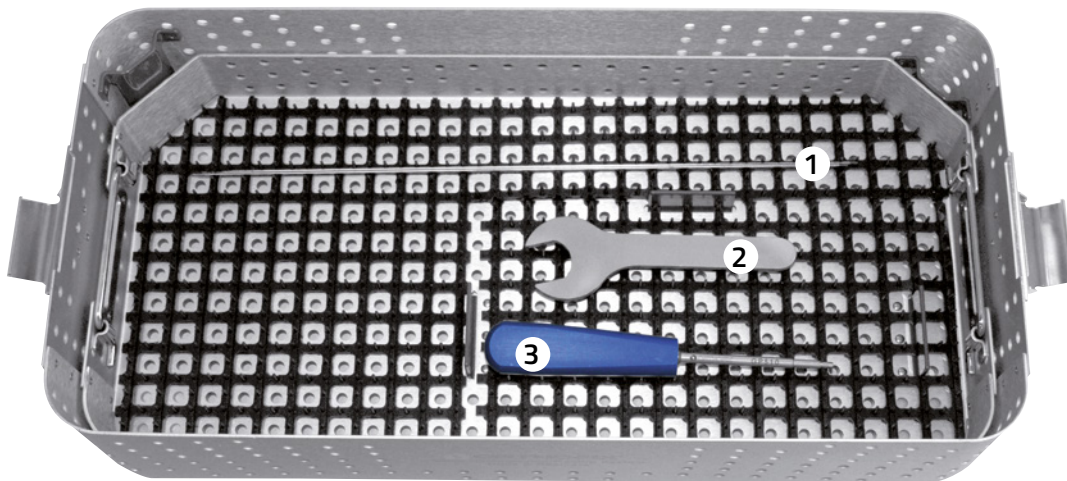

PATIENT SELECTION

- Patients with adequate soft tissue and vascular supply to allow for successful healing of wounds and fusion site.
- Patients with incomplete pain relief or deformity recalcitrant to appropriate conservative measures.

PREOPERATIVE PLANNING

- Note rotation of opposite side.
- Standard and hindfoot alignment view weight-bearing radiographs.
- Ensure radiographic findings match patient's symptoms. When in doubt, perform differential intra-articular injection.



TIP: 150mm nails are generally chosen for post-traumatic and talar deficient cases. 200mm and longer nails that extend proximal to the isthmus are generally chosen for Charcot/neuropathic conditions. This will decrease the probability of post-operative fracture due to stress riser at the tip of the nail.



NOTE: 250mm and 300mm nails require free-hand placement of the most proximal set of the tibial locking screws.

PATIENT POSITIONING

Examine the contralateral limb and check the rotation of foot relative to limb. In addition to a general anesthetic, a regional block (i.e. popliteal) performed PRIOR to the procedure provides optimal post-operative pain control. A thigh tourniquet should then be placed and elevated upon surgeon's preference.

There are several options for patient positioning including supine, lateral decubitus, and prone. These are dependent on patient anatomy, previous incisions, bone defects, and surgeon's preference. Supine with a roll/bump under the ipsilateral hip on a radiolucent operating table with the leg elevated seems to offer the most advantages. This roll should be placed in such a manner that the leg is in neutral position (i.e. patella is straight up).

Supine Position Advantages:

- a) Permits the standard approaches for ankle and subtalar arthrodesis.
- b) Facilitates ML/LM targeting.
- c) Easier to perform with larger patients.

Supine Position Disadvantage: Placement of the posterior-anterior (P-A) screw can be more difficult.

C-ARM POSITIONING

The C-arm monitor should be positioned at 90 degrees to the table on the affected side, on the opposite side of the C-arm.

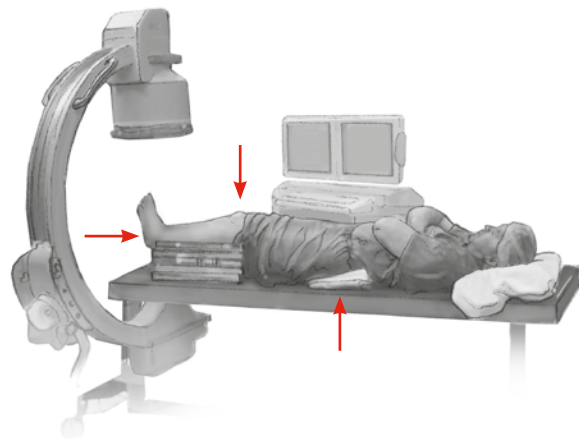

Measurement of Nail Length

The X-Ray Ruler (177275) can be used in combination with fluoroscopy to determine the appropriate nail length (*and diameter*). Ideal placement of the X-Ray Ruler would be on the side of the leg closest to the image intensifier where the base of the Nail Indicator will approximately locate the base of the Nail.

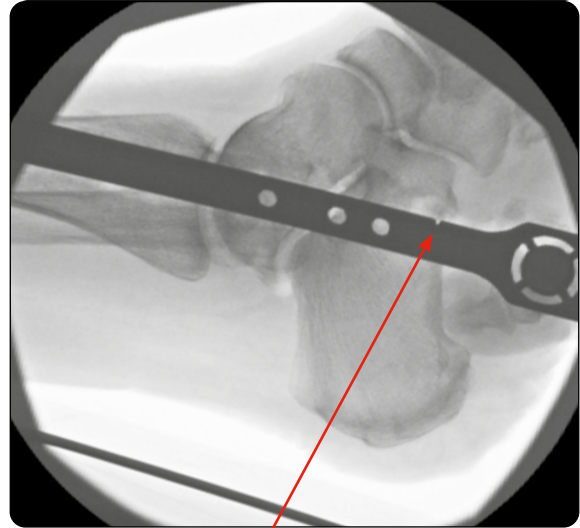
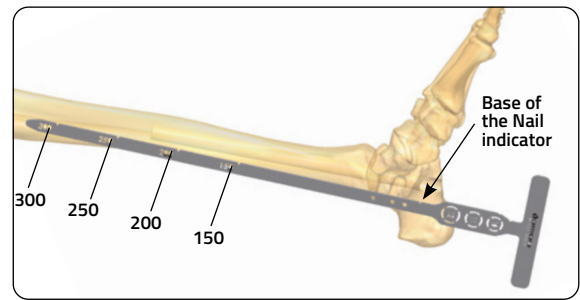

Base of the Nail Indicator

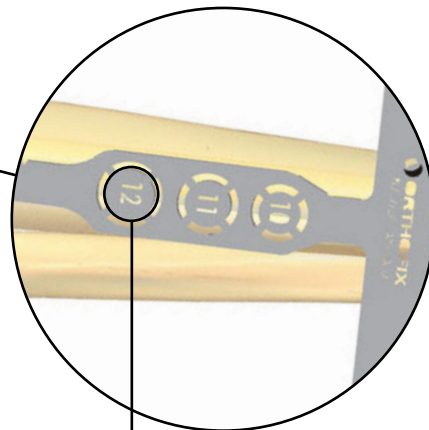
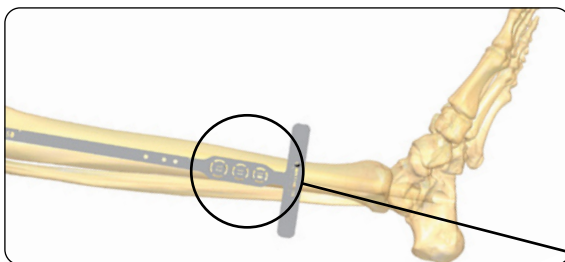

Inner circle represents the proximal diameter of the Nail

SURGICAL APPROACH

Multiple approaches have been well described for ankle arthrodesis. These include lateral, medial, anterior, combined medial and lateral, as well as posterior approach.

Joint Preparation

The joint preparation may be either a flat cut or joint congruent type of resection. Both options have their advantages. The choice of approach and type of resection are surgeon's preference. The subtalar joint is prepared in standard fashion with chisels or curettes to remove all remaining cartilage and fibrous tissue and achieve a bleeding bed of corticocancellous bone. Ideally during the resection of the distal tibia and proximal talus, no more than 6mm is removed from each side. Excess resection may lead to excessive limb shortening or inadequate talus bone stock for fixation. The medial wall or face of the talus should align with medial shaft of the tibia. It is often most successful to correct the deformities with the resection rather than rely on the implant to achieve reduction.

Ankle Positioning and Alignment

The ideal position of arthrodesis is neutral dorsiflexion (the foot is at a 90-degree angle to the long axis of the tibia) with 5-7 degrees of hindfoot valgus and external rotation symmetrical with the opposite side.¹

If the opposite side does not have normal anatomy, then consider aligning the crest of the tibial shaft with the 2nd ray. **The hindfoot position should be established and maintained prior to guide wire insertion, reaming, and nail insertion to ensure the nail does not change the foot position after it is inserted.**

Entry Point Incision and Guide Wire Insertion

These steps are critical and have a great influence on both the rest of the case and the patient's clinical result. Time invested with these steps is well spent and makes the remaining steps and result ideal.



TIPS:

- 1) The optimal insertion point for the Nail is immediately lateral to the plantar calcaneus' midpoint and in line with the longitudinal tibial axis.¹
- 2) To ease the use of fluoroscopy, many have found it helpful to have the operative side elevated to decrease fluoroscopic interference from the contralateral limb.
- 3) A longitudinal incision made prior to wire placement can allow for easier wire adjustment on the plantar aspect of the calcaneus.

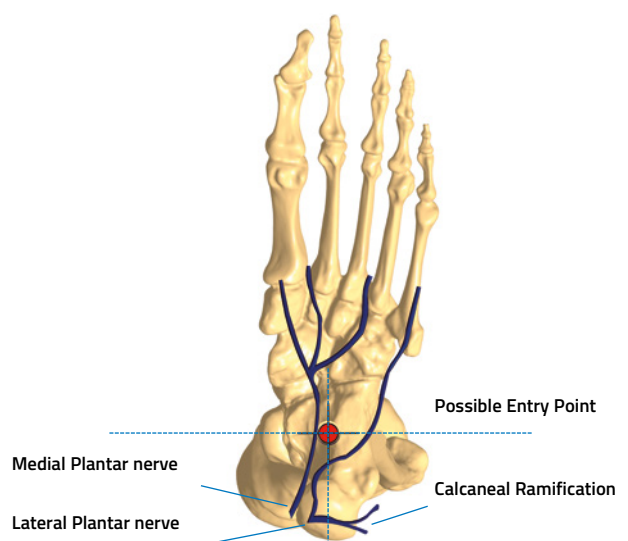
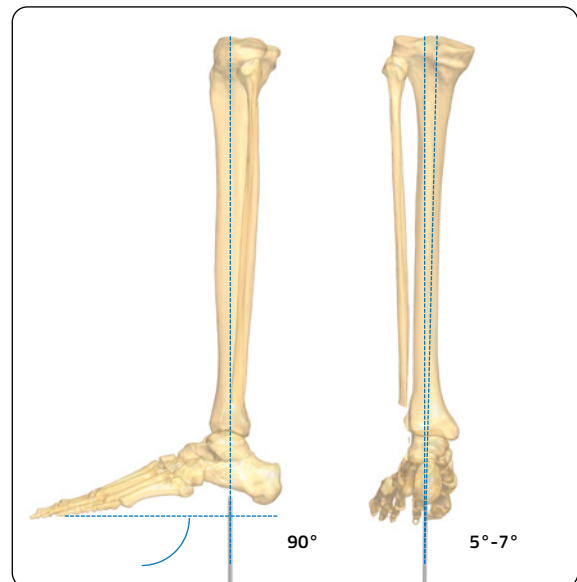

Part #	Description
177290	3.2mm x 400mm entry Guide Wire

After the ankle and subtalar joints have been prepared for arthrodesis, the 3.2mm x 400mm Entry Guide Wire (177290) is placed.

With the C-arm in the AP view, use the guide wire as a guide to mark the center of the tibia with a marking pen to help align the guide wire.

Perform an axial view of the calcaneus and mark the axis of the calcaneus with a marking pen.

Next, insert the 3.2m x 400mm Entry Guide Wire (177290) while viewing alignment via fluoroscopy in the lateral view. With the hindfoot aligned as previously described, the Entry Guide Wire is placed starting just anterior to the heel fat pad and in line with the center of the calcaneal axis.

Place the wire under power and confirm placement in all 3 views. Foot and ankle should be 90 degrees to tibial shaft.

- AP view - Medial wall of talus aligns with medial tibial diaphysis.
- Axial view - Guide wire centered on calcaneus axis.
- Lateral view - Foot and ankle 90 degrees to tibial shaft. Control forward foot shift. This can result in awkward gait if foot is translated anterior relative to the tibia.



CAUTION:

- 1) Maintain proper hindfoot position prior to and during guide wire insertion to ensure the Nail does not change foot position.
- 2) Failing to control forward foot shift can result in awkward gait if foot is translated anterior relative to tibia.

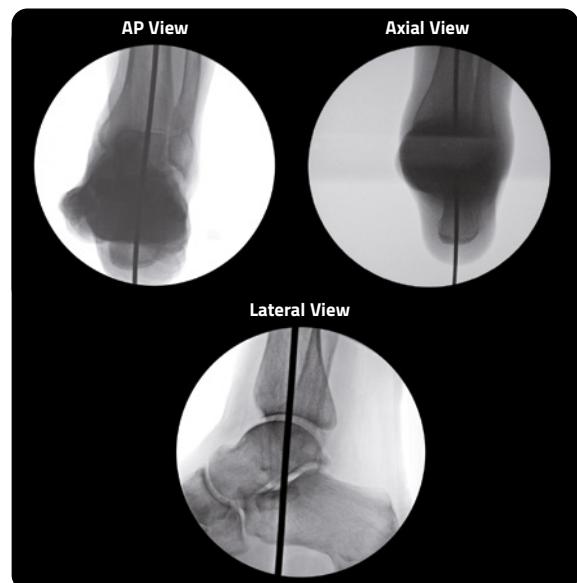
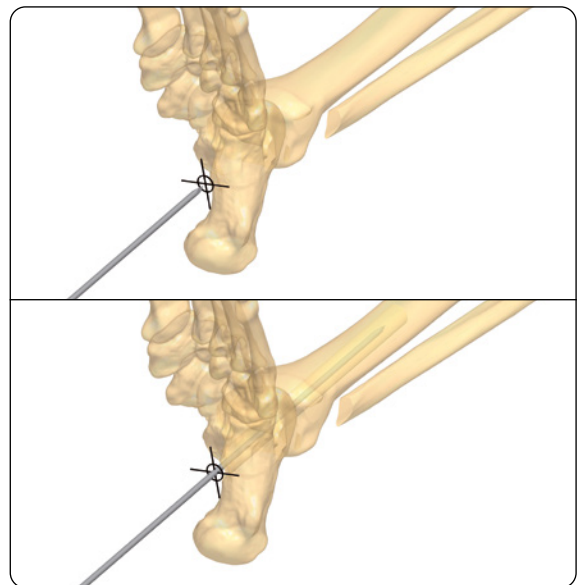

Part #	Description
177290	3.2mm x 400mm entry Guide Wire
177302	Entry Tissue Sleeve
177215	7mm Bushing
177287	7mm Entry Drill
177216	9mm Bushing
177288	9mm Entry Drill

A 3cm longitudinal incision is performed for the Entry Tissue Sleeve (177302). Bluntly dissect to the plantar fascia and divide it longitudinally. Continue dissection with an elevator to the plantar aspect of the calcaneus. Retract the neurovascular (NV) bundle (lateral plantar nerve) to the medial side using a blunt right angle retractor. Insert the Entry Tissue Sleeve (177302) to the plantar calcaneal bone surface and remove the retractor.

Thread the 7mm Bushing (177215) into the Entry Tissue Sleeve (177302). Insert the 7mm Entry Drill (177287) over the Entry Guide Wire and drill through calcaneus, talus, and up to the tibial plafond.



NOTE:

- 1) Entry Drills and Bushings are color-coded for ease of identification.
- 2) The 7mm and 9mm drills bottom out on their respective bushings.

Replace the 7mm Bushing with the 9mm Bushing (177216) and insert the 9mm Entry Drill (177288) over the Entry Guide Wire, drilling up to the tibial plafond.

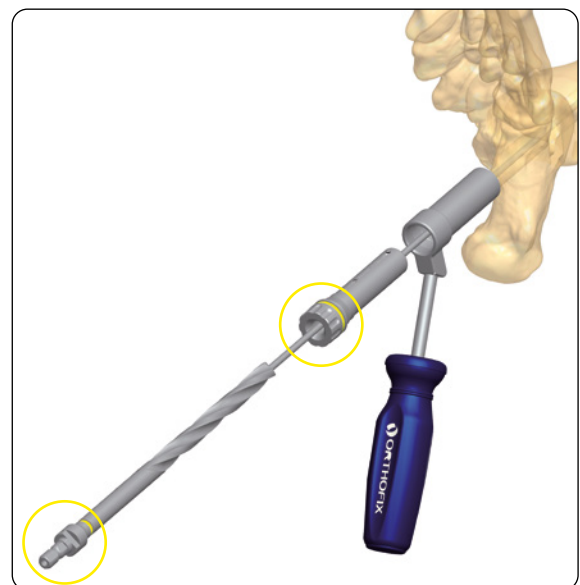
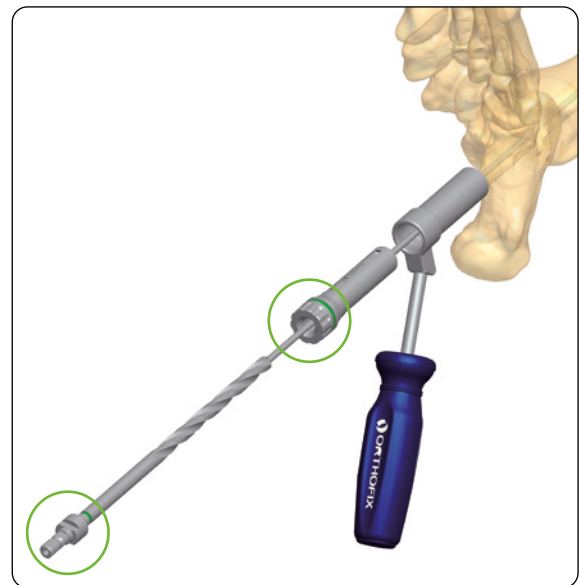

Part #	Description
177289	13mm Entry Reamer
99-177281	3.0mm x 800mm Ball Tip Guide Wire
177291	Reaming Wire Pusher

Remove the 9mm Bushing and insert the 13mm Entry Reamer (177289) over the Entry Guide Wire and ream through the calcaneus, talus and up to the tibial plafond.

 **NOTE:** The 13mm reamer bottoms out on the entry Tissue Sleeve (177302)

Replace the 3.2mm x 400mm Entry Guide Wire with the 3.0mm x 800mm Ball Tip Guide Wire (99-177281) and insert it to desired depth.



Attach the 9mm Flexible Reamer Head (Flexible Reamer Tray, 172001C for US market and 172001 for intl market) on to the Flexible Reamer Shaft. Slide the Flexible Reaming assembly onto the Ball Tip Guide Wire. Continue to ream the medullary canal of the tibia sequentially in 0.5mm increments until the desired depth and diameter is reached. Confirm successful reaming with fluoroscopy in both AP and ML planes. A Reaming Wire Pusher (177291) is provided to keep the guide wire in place while performing these reaming steps.



TIPS:

- 1) Nail diameter is dictated by the size of the native tibia. In most cases, a 10mm diameter nail provides satisfactory stability to allow progression toward fusion.¹
- 2) In order to ensure Nail is inserted without excessive resistance:
 - a) Ream 0.5 to 1.0mm greater than the selected diameter with 150/200mm Nails
 - b) Ream 1.0-1.5mm greater than the selected diameter with 250/300mm Nails



CAUTION:

- 1) Aggressive over-reaming of the cortex to place a larger-diameter nail may compromise the cortex, leading to a stress fracture.¹
- 2) Nails should extend past stress risers in the tibial shaft such as previous screw holes from removed hardware or severely osteopenic bone.

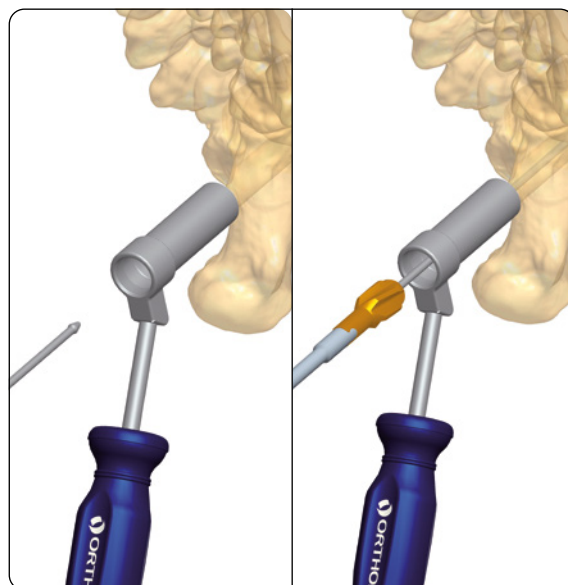

Nail Selection

Select Nail of appropriate length and diameter. Confirm internal locking and compression mechanisms are in the most distal (south) position of the slot(s).

Part #	Description
177120	Distal Targeting Arm
177100	Proximal Targeting Arm
177110	Nail Attachment Rod
177125	Heel Cup
177071	Impactor
177301	Locking Driver
177305	Compression Driver

If not, adjust accordingly using the Locking Driver (one black band) (177301). Next, utilize the Compression Driver (two black bands) (177305) in the same fashion.

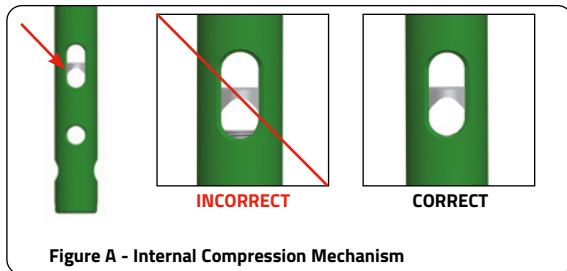

Targeting Arm Assembly

Press button on Distal Targeting Arm (177120) and assemble to shaft of the Proximal Targeting Arm (177100). Align the WHITE dot of the Distal Targeting Arm with the BLACK dot on the shaft of the Proximal Targeting Arm (177100). Next, slide and seat the Distal Targeting Arm onto the base of the Proximal Targeting Arm until each are flush with the other. When flush, rotate Distal Targeting Arm until the Targeting Assembly locks in place. Last, thread the Heel Cup (177125) onto the Proximal Targeting Arm.



CAUTION: Do not engage the button and rotate the Distal Targeting Arm at the same time. This can cause the Targeting Assembly to disengage.

Nail Assembly

Thread the Nail Attachment Rod (177110) into the base of the Proximal Targeting Arm (177100).

Align three tabs of Nail (female end) with tabs on Nail Stand (male end) and fully seat. Thread Nail Attachment Rod into Nail by hand. Use Impactor (177071) to fully tighten.

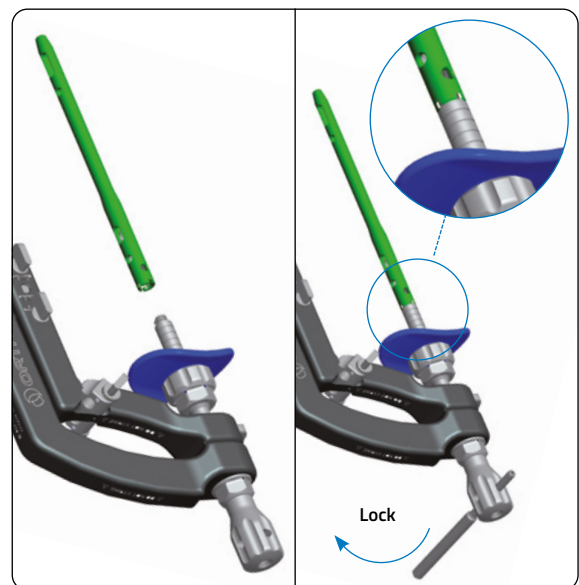
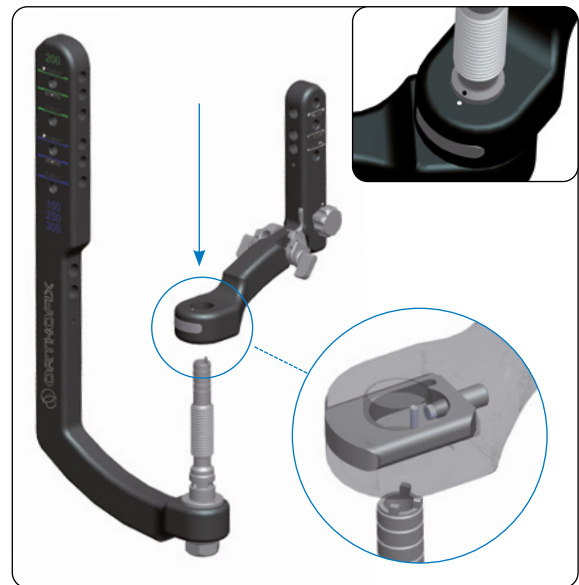

Alignment Check

Part #	Description
177211	Screw Guide
177213	4.3mm Drill Guide
177286	4.3mm Calibrated Drill
177100	Proximal Targeting Arm
177120	Distal Targeting Arm
177125	Heel Cup

Prior to inserting Nail, perform an alignment check between the Nail and Targeting Assembly on the back table. Verify using the Screw Guide (177211), 4.3mm Drill Guide (177213), and 4.3mm Calibrated Drill (177286) in each applicable hole.



CAUTION: Verify that the drill smoothly enters and exits the talar hole. Adjust the internal locking and compression mechanisms if necessary prior to inserting the Nail. The position of the internal mechanism must be flush with the bottom of the compression slot. If not, adjust accordingly using the Locking Driver (177301) and Compression Driver (177305). Refer to Page 15, Figure A, Internal Compression Mechanism.

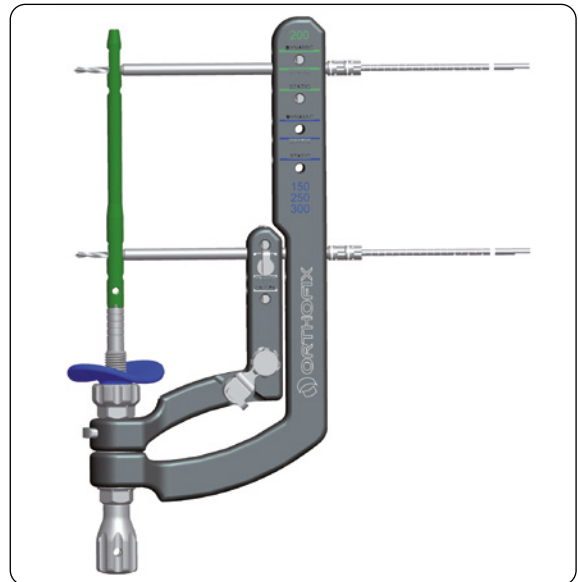

Targeting Arm Orientation

The Proximal Targeting Arm (177100) should be positioned in the orientation (medial or lateral) for which the tibial screws will be inserted. The Distal Targeting Arm (177120) should be aligned in the orientation (medial or lateral) for which the talar screw will be inserted.



TIPS:

- 1) Proximal screws placed medial to lateral (M-L) provide easier access to drilling and measuring for appropriate screw. Disadvantage: Proximal screws placed M-L can lead to screw head prominence; especially in very thin patients. If such scenario presents itself, consider placing proximal screws in the L-M orientation.
- 2) If the surgeon chooses to preserve the fibula in its anatomic position, the screw centered in the talus may be placed from the medial side. This will allow unrestricted compression across the tibio-talar joint. When the Nail is inserted in the correct position, the screw will enter anterior and distal to medial malleolus and dorsal to the posterior tibial tendon. The NV bundle will typically be located posterior and distal to the talar screw placement.
- 3) The Distal Outrigger Assembly allows the surgeon to choose the position of the screws in the calcaneus. Remember the calcaneus is slightly externally rotated relative to the talus and the Targeting Assembly can be slightly externally rotated to achieve a central position of the posterior to anterior calcaneal screw in the calcaneus.

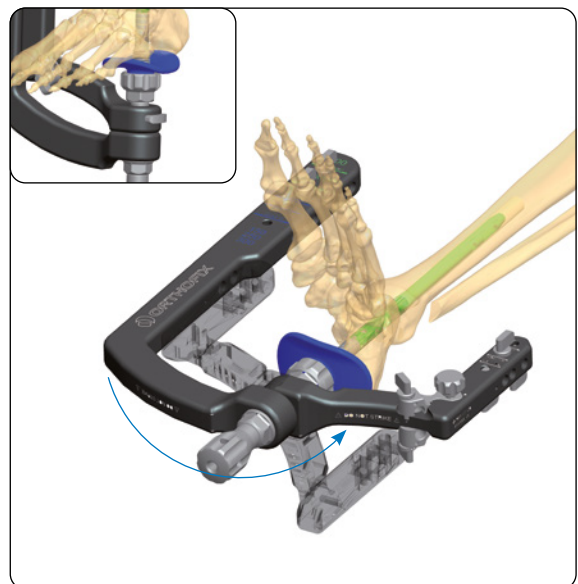

Nail Insertion

Part #	Description
177110	Nail Attachment Rod
177380	Slotted Mallet
177385	Slotted Mallet Adaptor
99-177282	2.5mm x 800mm Guide Wire
17353	Guide Wire Exchange Tube
99-177281	3.0mm x 800mm Ball Tip Guide Wire



CAUTION: The Ball Tip Wire must be removed before inserting Nail. The Ball Tip Wire will not pass through the Nail due to the internal compression mechanism.

Insert Nail. The Nail Attachment Rod (177110) and the Slotted Mallet (177380) can be used in conjunction with the Slotted Mallet Adaptor (177385).



CAUTION: Do not strike any other area of the Targeting Assembly as this can cause damage and compromise accuracy.



NOTE: If passing the Nail over a guide wire is desired, use the 2.5mm x 800mm Guide Wire (99-177282). An Exchange Tube (17353) is available to facilitate the replacing of the 3.0mm x 800mm Ball Tip Guide Wire (99-177281).

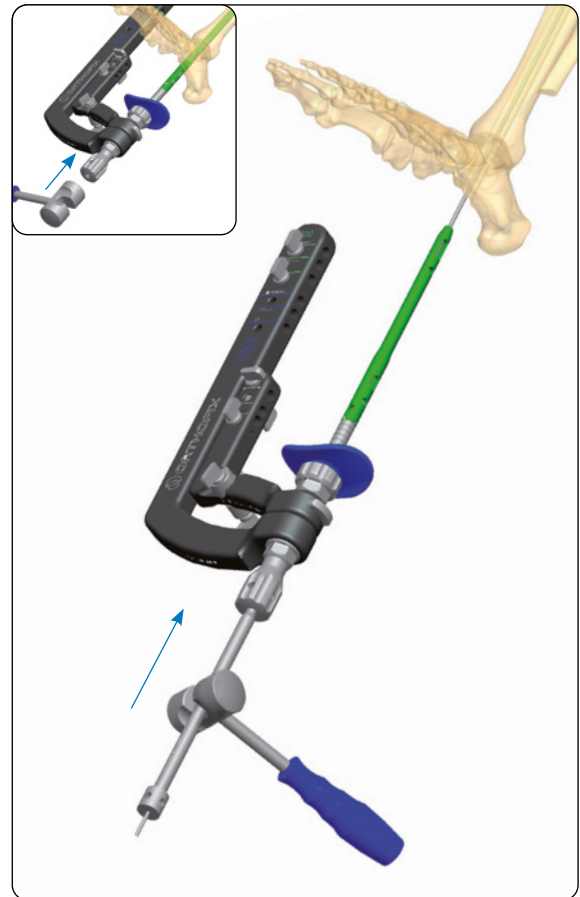

Nail Positioning/Countersinking

Part #	Description
177290	3.2mm x 400mm Entry Guide Wire

Insert the Nail and countersink a minimum of 5mm. Verify that there is no calcaneal prominence in more than 1 plane. With the base of the Nail identified, align the talar screw hole in the body of the talus.

Confirm the Nail position using fluoroscopy; adjusting the Nail placement as necessary. This step is critical for optimal result. Time invested will determine the overall success of the case!



CAUTION: Prominent (i.e. proud) nails are poorly tolerated.

- 1) The Nail should be countersunk a minimum of 5mm into the plantar aspect of the calcaneus.
- 2) Manual compression of the arthrodesis site is essential in order to account for the soft tissue (fat pad) of the heel.
- 3) Remain cognizant of the calcaneal anatomy.

Nail Base Identification

The base of the Nail can be determined by:

1. Using fluoroscopy, locate the first groove on the Barrel, which is the interface between the Nail and the Nail Stand. The remaining grooves are 5mm apart and can be used as an aid for countersinking.
2. Inserting the 3.2mm x 400mm Entry Guide Wire (177290) in the most distal K-wire hole of the Proximal or Distal Targeting Arms.



TIP: Positioning the Distal Targeting Arm in the posterior position can improve the fluoroscopy imaging.

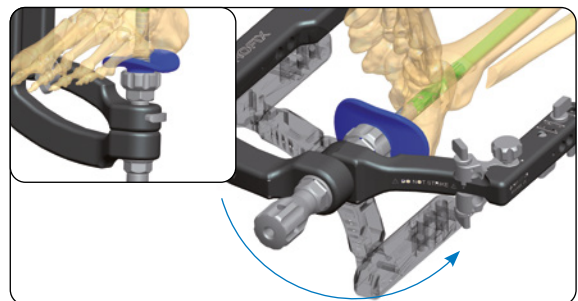
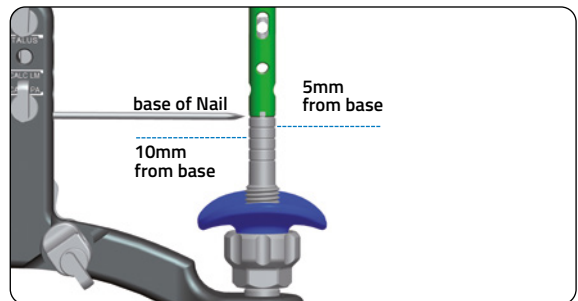
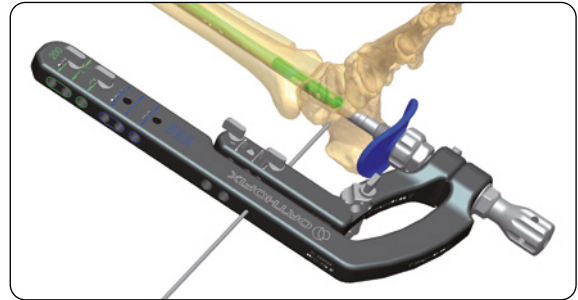
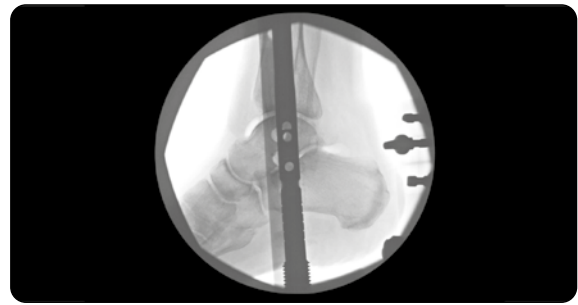

1st screw placement - Talar Screw



CAUTION: Remove Guide Wire prior to drilling.

Once the Nail has been inserted to the proper depth, the orientation of the Nail should be determined based on the preferred trajectory of the P-A calcaneal screw.

Part #	Description
177211	Screw Guide
177212	Trocar
177213	4.3mm Drill Guide
177286	4.3mm Calibrated Drill
177320	3.5mm Hex Screw Driver
177340 or 177350	Ratcheting Handle
177300	Long Depth Gauge

The P-A calcaneal screw is perpendicular to the talar screw. Once the rotation of the nail is appropriate, drill the talus using the Screw Guide (177211), Trocar (177212), 4.3mm Drill Guide (177213), and 4.3mm Calibrated Drill (177286). Measure and insert the appropriate length Low Profile (magenta) Screw (T774xxx) using the 3.5mm Hex Screw Driver (177320), Ratcheting Straight Handle (177340), Ratcheting T-Handle (177350), or power.



TIPS:

- 1) The Ankle Hindfoot Nailing System allows the freedom to determine the trajectory of the P-A calcaneal screw. The normal anatomy of the longitudinal axis of the calcaneus is approximately 10 degrees externally rotated relative to the tibial crest. This orientation also allows for maximum purchase with respect to the calcaneal screw length.
- 2) The Distal Targeting Arm can be used to aid with proper rotation of the Nail by positioning in the posterior position.
- 3) When inserting tibial screws in the M-L orientation:
a slight external rotation of the Targeting Assembly relative to the tibia will minimize "skiving" off the medial tibial cortical face.
- 4) When inserting tibial screws in the L-M orientation:
a slight internal rotation of the Targeting Assembly relative to the tibia will minimize fibular interference.



NOTE: The system offers both a calibrated drill for measuring distal screws, as well as the Long Depth Gauge (177300). Utilize the tissue protection sleeve-drill guide-4.3mm calibrated drill in a traditional fashion. The same instruments are used to implant the tibia screws in the 150mm, 200mm Nails, as well as the 250mm, 300mm nails (distal tibia holes).

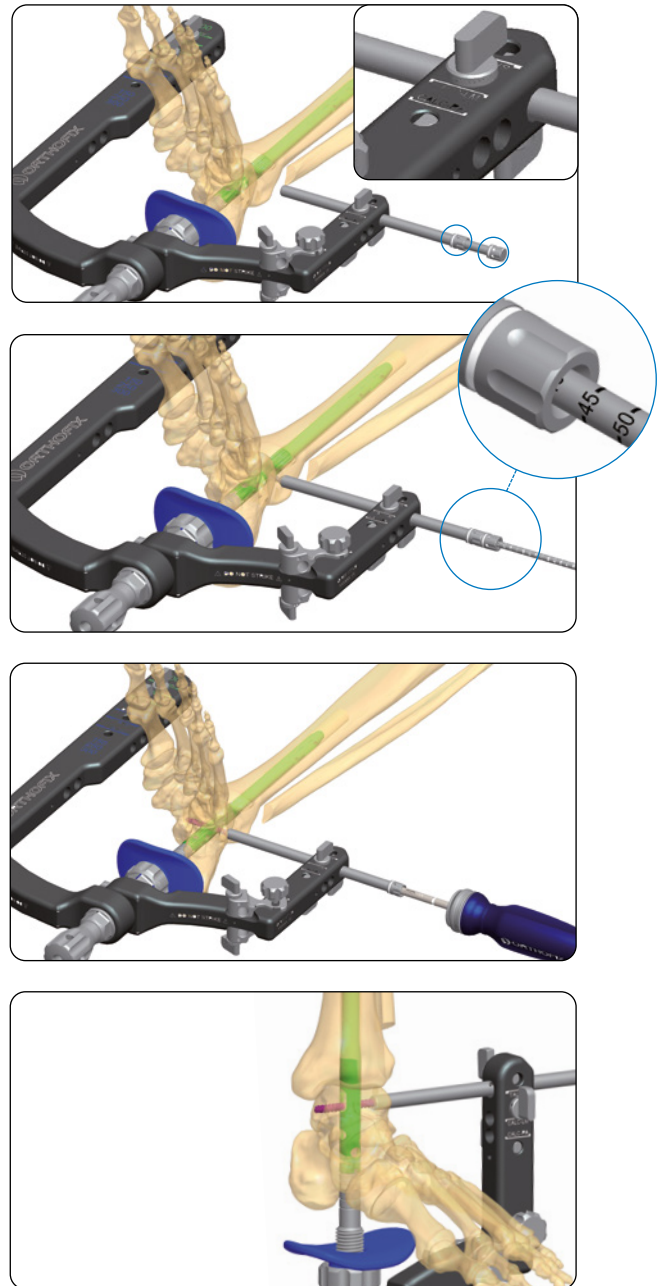

Tibial Screw Placement x 2

After drilling and measuring as previously described, insert the Low Profile (magenta) Screw (T774xxx) (static hole first) into the appropriate hole labeled on the Proximal Targeting Arm for each Nail (150, 200, 250, 300mm). Next, insert the second Low Profile (magenta) Screw (T774xxx) into the oval slot; either the static or dynamic position. The dynamic position is marked on the Proximal Targeting Arm and corresponds with the top portion of the slot.



TIP: The position of the Nail with respect to final rotation will be set following preparation and insertion of tibial screws.¹



CAUTION: Do not lean on Targeting Assembly as Nail flexion might occur and targeting could be compromised.



NOTE: There are 2 options for proximal screw placement in the 250 and 300mm Nails.

- 1) Proximal Targeting Arm - This option allows the surgeon to target the distal set of the tibial holes. This targeting option is available with all nail diameters and lengths.
- 2) Freehand - The second option allows the surgeon to "free-hand" the proximal set of the Tibial holes using the 4.3mm Freehand Drill (177284) and Short Depth Gauge (177304).

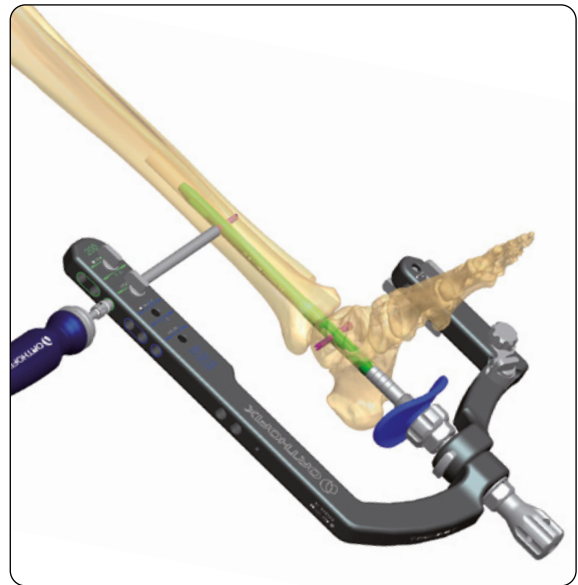

Locked Talar Screw (optional)

Part #	Description
177301	Locking Driver
177340	Ratcheting Straight Handle
177305	Compression Driver

Attach the Locking Driver (one black band) (177301) marked "1" to the Ratcheting Straight Handle (177340) and insert through the cannulation in the Nail Attachment Rod (177110). Engage the Locking Driver with the internal locking mechanism and lock the talar screw by turning clockwise until hand tight.



CAUTION:

- 1) Do not over-torque during the locking of the talar screw. Over tightening can cause difficult screw removal in the future and can damage the mechanism.
- 2) Refrain from using the Ratcheting T-Handle (177350). The potential to over-torque is increased with this instrument.



NOTE: The talar screw must be locked at this stage if locking is desired.



TIP: Along with the locking of the calcaneal screws, locking the talar screw creates a fixed angle construct.

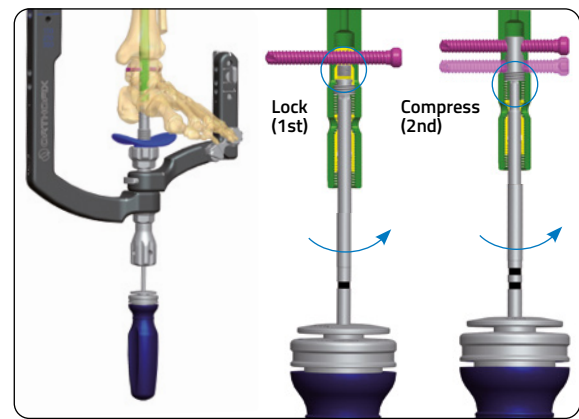

Internal Compression (Talus to Tibia)

To internally compress the tibio-talar joint, attach the Compression Driver (two black bands) (177305) marked "2" to a Ratcheting Handle and insert through the Nail Attachment Rod. Engage Compression Driver with internal mechanism and rotate clockwise to compress the tibio-talar joint.



CAUTION:

- 1) Do not over-torque locking and internal compression mechanism.
- 2) Refrain from using Ratcheting T-Handle (177350). The potential to over-torque is increased with this instrument.
- 3) Avoid over-compressing the arthrodesis site! Internal compression should be monitored via fluoroscopy.



NOTE:

- 1) Up to 7mm of mechanical compression can be achieved through the internal compression mechanism.
- 2) The compression driver (177305) serves as a tool in determining the amount of internal tibio-talar compression. The amount of compression is observed via markings on the side of the compression driver. Each mark equals (=) 2mm compression.

External Compression (calcaneus to talus)

Part #	Description
177072	24mm Wrench
177125	Heel Cup

To compress the subtalar joint, the 24mm Wrench (177072) should be used to turn the Heel Cup (177125) in a clockwise fashion. Advance the Heel Cup until the desired compression is achieved.



CAUTION:

- 1) Prior to compressing, take care to estimate how much compression will be needed to avoid unwanted soft tissue impingement, irritation and nail protrusion.
- 2) Avoid over-compressing the arthrodesis sites! External compression should be monitored via fluoroscopy.

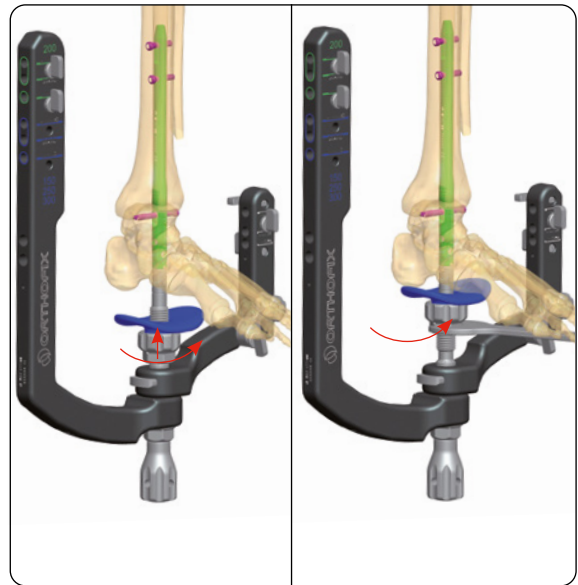

Placement of Calcaneal Screws

Calcaneal Screw LM Placement

Lateral-Medial (L-M) "CALC LM" Screw

After internal and external compression, position the Distal Targeting Arm on the lateral side of the ankle (recommended as shown). Insert the Screw Guide and Drill Guide in the "CALC-LM" hole. After having drilled and measured the correct screw length, insert a Low Profile (magenta) Screw (T774xxx) using previously described technique.



NOTE: The order of calcaneal screw placement is irrelevant. However, by first inserting the screw in the frontal or coronal plane, this will help minimize repositioning of the Distal Targeting Arm.

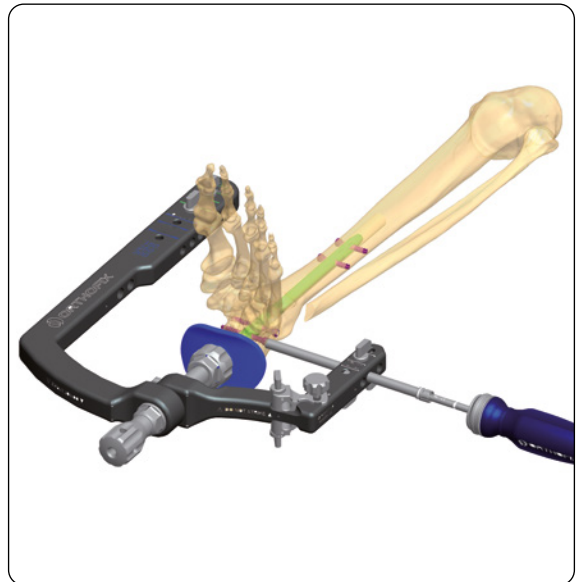

Posterior-Anterior (PA) "CALC-PA" Screw

Part #	Description
177292	Countersink (optional)
177283	6.1mm Drill (optional)
177286	4.3mm Calibrated Drill

Position the Distal Targeting Arm on the posterior side of the ankle. Insert the Screw and Drill Guide in the "CALC-PA" hole.

After having drilled and measured the correct screw length, insert a Low Profile (magenta) Screw (T774xxx) or Threaded Head (dark blue) Screw (T775xxx).

If using the Low Profile (magenta) Screws (T774xxx) in the calcaneus, the Countersink (177292) can be used to reduce screw head prominence in the heel. Insert the Countersink through the Screw Guide.

Be sure to account for any countersinking when selecting the appropriate screw length.



NOTE:

- 1) The Threaded Head Screw (dark blue) is designed to minimize soft tissue irritation.
- 2) A 6.1mm Drill (177283) can be used to drill the near cortex (only). This drill should be used in conjunction with the 4.3mm Calibrated Drill (177286). Use of the 6.1mm Drill is recommended with hard (sclerotic) bone.

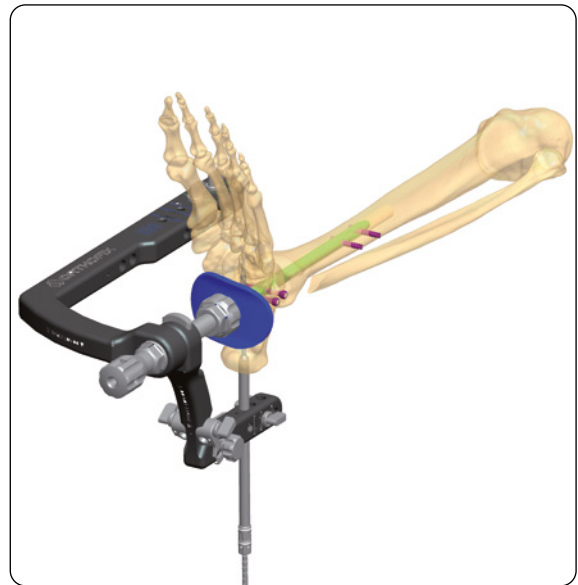

Oblique Supplementary Screw Fixation (Optional)

The oblique supplementary screw is useful to obtain increased rigidity of the construct and to maintain compression before release of the external heel compression. The oblique aiming guide allows for quick and precise screw placement by providing the surgeon with a visual reference that ensures the screw is inserted within the "safe zone."

After final external compression has been applied, place the Screw Guide through the Oblique Guide lateral to Nail (recommended). Loosen the Oblique Guide Knob and adjust (click) the Oblique Guide to one (1) of the black markings (see next page). Securely tighten the knob to lock the position. Drill and measure the correct screw length using the Drill Guide and 4.3mm Calibrated Drill. The C-arm should be in the lateral position. View the drill via fluoroscopy to ensure appropriate length and placement.

If warranted, use the 6.1mm Drill through the near cortex (only). Insert appropriate length Low Profile or Threaded Head Screw. If using Low Profile Screws (T774xxx) in the calcaneus, the Countersink (177292) can be used to reduce screw head prominence in heel.

Be sure to account for any countersinking when selecting the appropriate screw length.

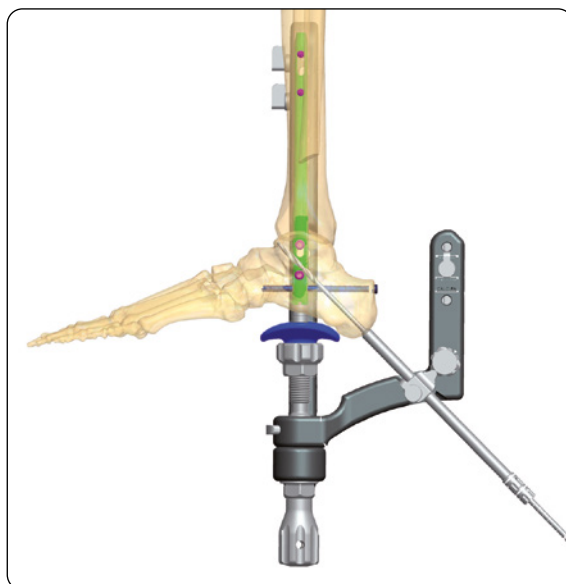

* *Black markings on the Oblique Guide = "Safe Zone"*

- *North Black Mark = Superior to Talar Screw*
- *Center Black Mark = Between Talar and Lateral Calcaneal Screw*
- *South Black Mark = Inferior to Lateral Calcaneal Screw*

Each tactile ridge indicates 2 degree angulation for precise targeting through the calcaneus, talus and mid-foot.



NOTE:

- 1) **"Safe zone"* - defined as a trajectory for screw placement that avoids the implanted hardware - nail and screws (talar and both calcaneal screws). Outside or between the black markings = *"non-safe"* zone; interference with existing hardware will occur (nail-talar-calcaneal screws x 2).
- 2) The supplementary screw should be placed after the internal compression at the tibiotalar joint and after use of the external compression heel cup, but ideally before releasing the compression gained from the external compression heel cup. This will provide for rigidity to the subtalar fusion.
- 3) The optimal position for the supplementary screw is lateral to the Nail. The lateral position allows for an increased amount of bony purchase from the calcaneus to the tibia. A medially placed screw will achieve less bony purchase in the calcaneus than a laterally placed screw.



CAUTION: If more calcaneal bone is medial to the Nail, the hindfoot is likely malpositioned in varus. However, an exception to this rule may occur when a patient has had a previous ankle fusion with lateralization of the hindfoot. A laterally based supplementary screw may pass lateral to the talus and tibia providing very little bony purchase proximally.

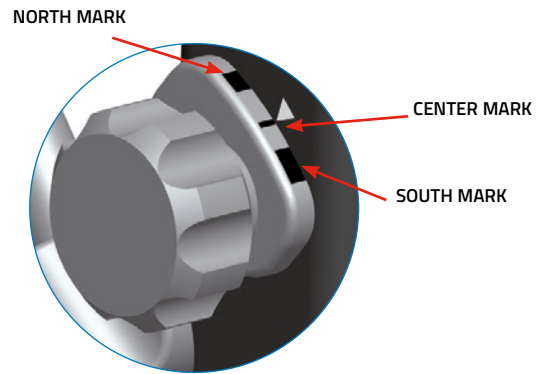

Targeting Assembly Removal

Part #	Description
177110	Nail Attachment Rod

Loosen the Nail Attachment Rod (177110) from the Nail by rotating counter-clockwise. Carefully pull and remove the Targeting Assembly from the Nail.

Locking End Cap Insertion

Part #	Description
GP510	3.5mm Cannulated Hex Driver
177387	1.8mm x 350mm Guide Wire

Select the appropriate Locking End Cap (0, 5, 10mm). Utilizing the 3.5mm Cannulated Hex Driver (GP510) and the 1.8mm x 350mm Guide Wire (177387). Insert the Locking End Cap in a cannulated fashion. Confirm placement with fluoroscopy.



NOTE: The Locking End Cap is required to lock the two (2) calcaneal screws. Tighten the End Cap until secure in place.



CAUTION: Refrain from leaving the Nail, in combination with the selected Locking End Cap, prominent on the plantar aspect of the foot.¹

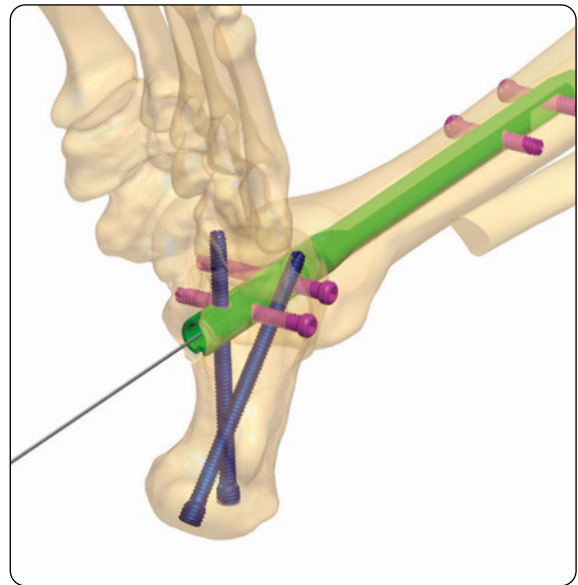

NAIL REMOVAL

Extraction Tray empty (177996)

Extraction Tray full (450439C for US Market)

INSTRUMENTS TRAY

Part #	Description
Single Tray	
SMN173370	1 Slap Hammer
177385	2 Slotted Mallet Adaptor
177391	3 Cross-Threading Adaptor
177390	4 Slap Hammer Adaptor
177071	5 Impactor
177340	6 Ratcheting Straight Handle
177380	7 Slotted Mallet

Part #	Description
Single Tray	
177394	8 Screw Head Gouge
177392	9 Screw Extractor, size 4
177393	10 Screw Extractor, size 5
177320	11 3.5mm Hex Screw Driver
177301	12 Locking Driver
177305	13 Compression Driver
177395	14 Needle Nose Vise Grips

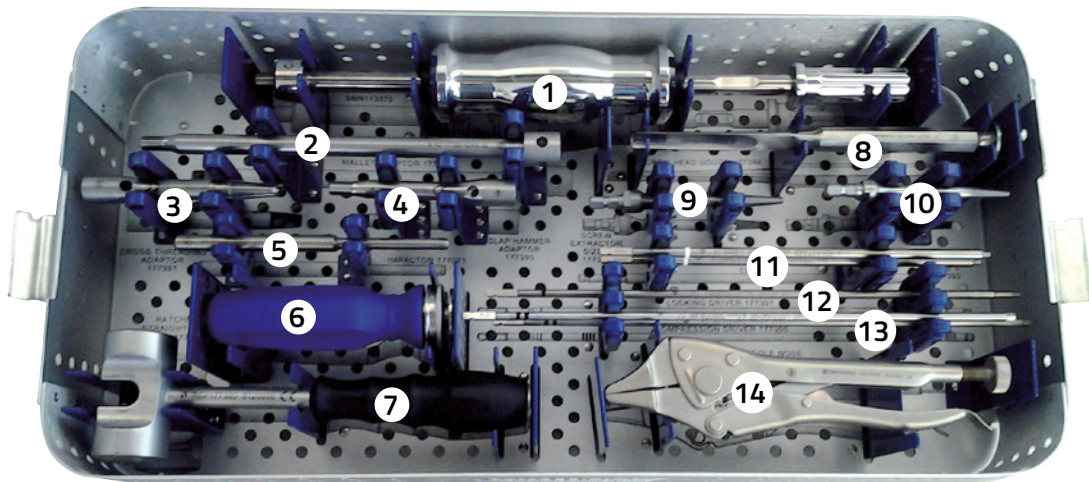

NAIL REMOVAL

Part #	Description
177392	Screw Extractor Size 4
177395	Needle Nose Vise Grips
177394	Screw Head Gouge
177340	Ratcheting Straight Handle
177393	Screw Extractor Size 5
177320	3.5mm Hex Screw Driver

1. Clear ingrowth at the base of the Nail, including hexagonal recess, to gain access to the Locking End Cap.
2. **Remove the Locking End Cap**
Remove the Locking End Cap using the 3.5mm Hex Screw Driver (177320) and the Ratcheting Straight Handle (177340).



NOTE: The following instruments can be utilized to gain access and remove the locking end cap and the screws:

Screw Head Gouge (177394): Use to expose screw head.

Screw Extractor, size 4 (177392): Reverse threaded design.

Screw Extractor, size 5 (177393): Reverse threaded design, more aggressive option compared to 177392.

Needle Nose Vise Grips (177395): Use when head of screw, or the Locking End Cap's hex, are completely compromised.



CAUTION: Do not use power equipment with screw extractors

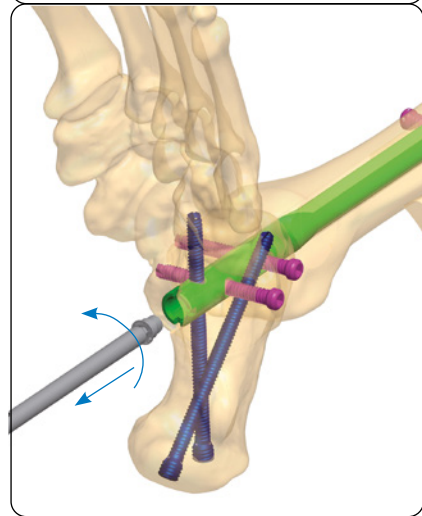
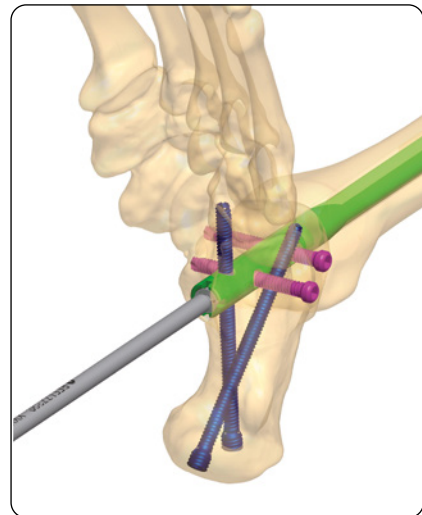

Part #	Description
177393	Screw Extractor Size 5
177392	Screw Extractor Size 4
177395	Needle Nose Vise Grip
177305	Compression Driver
177301	Locking Driver
177394	Screw Head Gouge
177340	Ratcheting Straight Handle
177320	3.5mm Hex Screw Driver

3. **Remove the Following Screws as Applicable**

Posterior-anterior (PA), lateral-medial (LM), and oblique supplementary screw. Use the 3.5mm Hex Screw Driver (177320)

4. **Talar Screw Unlocking and Decompressing**

Unlock the Talar Screw using the Locking Driver (177301) through the base of the Nail.

Next, decompress the internal compression mechanism using the Compression Driver (177305).

Next, proceed to remove the Talar screw using the 3.5mm Hex Screw Driver (177320).

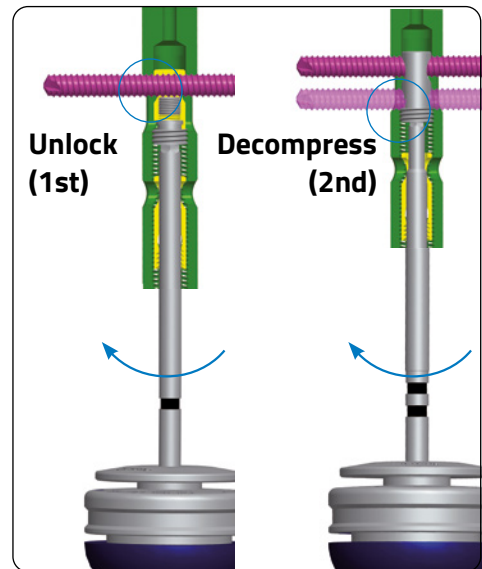
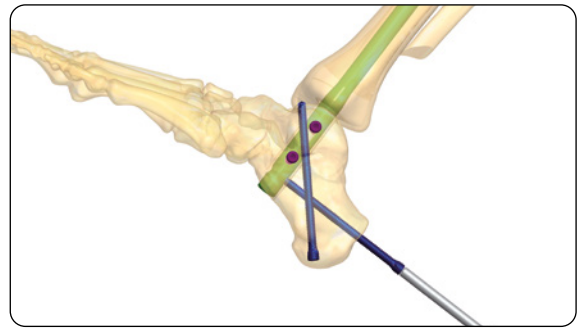

NOTES:

- 1) If there is bone growth blocking access to the head of the screw, use the screw head gouge and vise grips to clear away any bone that may prevent removal. Repeat the same operation for each screw.
- 2) If the screw hex feature is damaged, the Screw Extractors 177392 and 177393 can be used. The screw extractor must be driven in reverse (counter clockwise), at low speed, in order to bite into the screw hex for removal.

5. Thread in the Nail Removal Tool

Part #	Description
177385	Slotted Mallet Adaptor
177390	Slap Hammer Adaptor
177391	Cross-Threading Adaptor
177071	Impactor
SMN173370	SMN Slap Hammer

Thread the Slotted Mallet Adaptor (177385) into the base of Nail. The Impactor (177071) should be used to appropriately tighten the Slotted Mallet Adaptor (177385) into the Nail.



NOTES:

- 1) **Additional options for nail removal:**
Slap Hammer Adaptor (177390): Use in conjunction with the Slap Hammer (SMN173370).
- 2) **Cross-Threading Adaptor (177391):** Use when threads of Nail's base are compromised. Use in conjunction with the Slap Hammer (SMN173370).

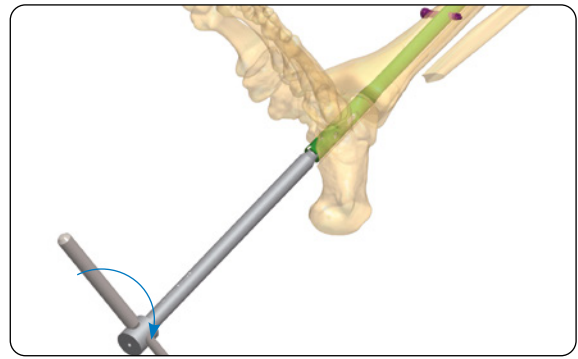

6. Tibia Screw

Part #	Description
177380	Slotted Malle
177340	Ratcheting Straight Handle
177320	3.5mm Hex Screw Driver

Remove the Tibial Screw(s) using the 3.5mm Hex Screw Driver (177320).



CAUTION: Ensure step 5 has been completed prior to attempting to remove Tibial Screws in order to prevent the Nail from migrating superiorly prior to removal.









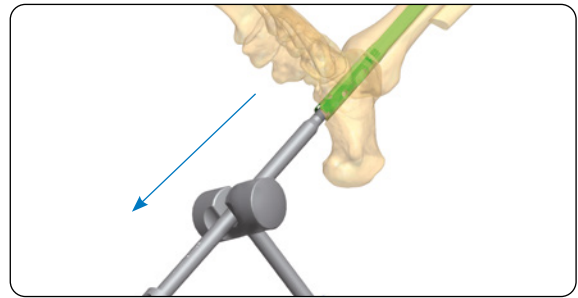
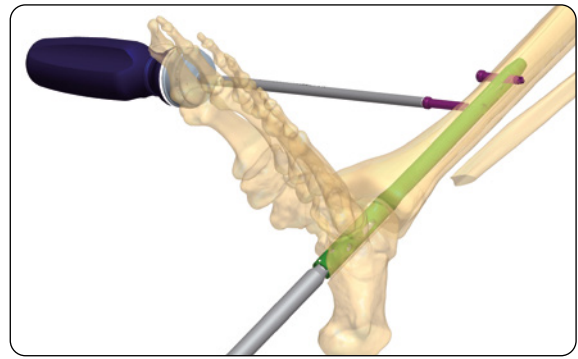

















Verify all hardware has been removed prior to wound closure.















7. Remove Nail



CAUTION: Verify all hardware has been removed prior to wound closure.



Instrumentation		
	Part#	Description
	177290	3.2mm x 400mm entry Guide Wire
	177302	Entry Tissue Sleeve
	177215	7mm Bushing
	177287	7mm Entry Drill
	177216	9mm Bushing
	177288	9mm Entry Drill
	177289	13mm Entry Reamer
	99-177281	3.0mm x 800mm Ball Tip Guide Wire
	177291	Reaming Wire Pusher
	177120	Distal Targeting Arm
	177100	Proximal Targeting Arm
	177110	Nail Attachment Rod
	177125	Heel Cup
	177071	Impactor
	177301	Locking Driver
	177305	Compression Driver
	177211	Screw Guide
	177213	4.3mm Drill Guide
	177286	4.3mm Calibrated Drill
	177380	Slotted Mallet
	177385	Slotted Mallet Adaptor
	99-177282	2.5mm x 800mm Guide Wire
	17353	Guide Wire Exchange Tube
	177212	Trocar
	177320	3.5mm Hex Screw Driver
	177350	Ratcheting Handle

Instrumentation		
	Part#	Description
	177340	Ratcheting Straight Handle
	177300	Long Depth Gauge
	177072	24mm Wrench
	177292	Countersink (optional)
	177283	6.1mm Drill (optional)
	GP510	3.5mm Cannulated Hex Driver
	177387	1.8mm x 350mm Guide Wire
	177392	Screw Extractor Size 4
	177395	Needle Nose Vise Grips
	177394	Screw Head Gouge
	177393	Screw Extractor Size 5
	177390	Slap Hammer Adaptor
	177391	Cross-Threading Adaptor
	SMN173370	SMN Slap Hammer

References

1. Quill, GE; Miller, SD: Tibiototalcaneal Arthrodesis Using A Medullary Nail. Lippincott Williams & Williams. Operative Techniques In Orthopaedic Surgery, Vol. 4, pp. 4161-4172, 2011.

Please refer to the "Instructions for Use" supplied with the product for specific information on indications for use, contraindications, warnings, precautions, possible adverse events, MRI (Magnetic Resonance Imaging) safety information and sterilization.

Electronic Instructions for use available at the website <http://ifu.orthofix.it>

Electronic Instructions for use - Minimum requirements for consultation:

- Internet connection (56 Kbit/s)
- Device capable to visualize PDF (ISO/IEC 32000-1) files
- Disk space: 50 Mbytes

Free paper copy can be requested from customer service (delivery within 7 days):

tel +39 045 6719301, fax +39 045 6719370,

e-mail: customerservice@orthofix.it

Caution: Federal law (USA) restricts this device to sale by or on the order of a physician. Proper surgical procedure is the responsibility of the medical professional. Operative techniques are furnished as an informative guideline. Each surgeon must evaluate the appropriateness of a technique based on his or her personal medical credentials and experience.



Manufactured by:
ORTHOFIX Srl
Via Delle Nazioni 9, 37012 Bussolengo
(Verona), Italy
Telephone +39 045 6719000,
Fax +39 045 6719380
www.orthofix.com

Rx Only

CE₀₁₂₃

Distributed by:

